



The complete
office collection.
Designed
for contemporary
working spaces.

Gallotti&Radice

**“L'architettura è, e resta, un meraviglioso processo di sintesi
in cui sono coinvolte migliaia di componenti umane.”**

Alvar Aalto

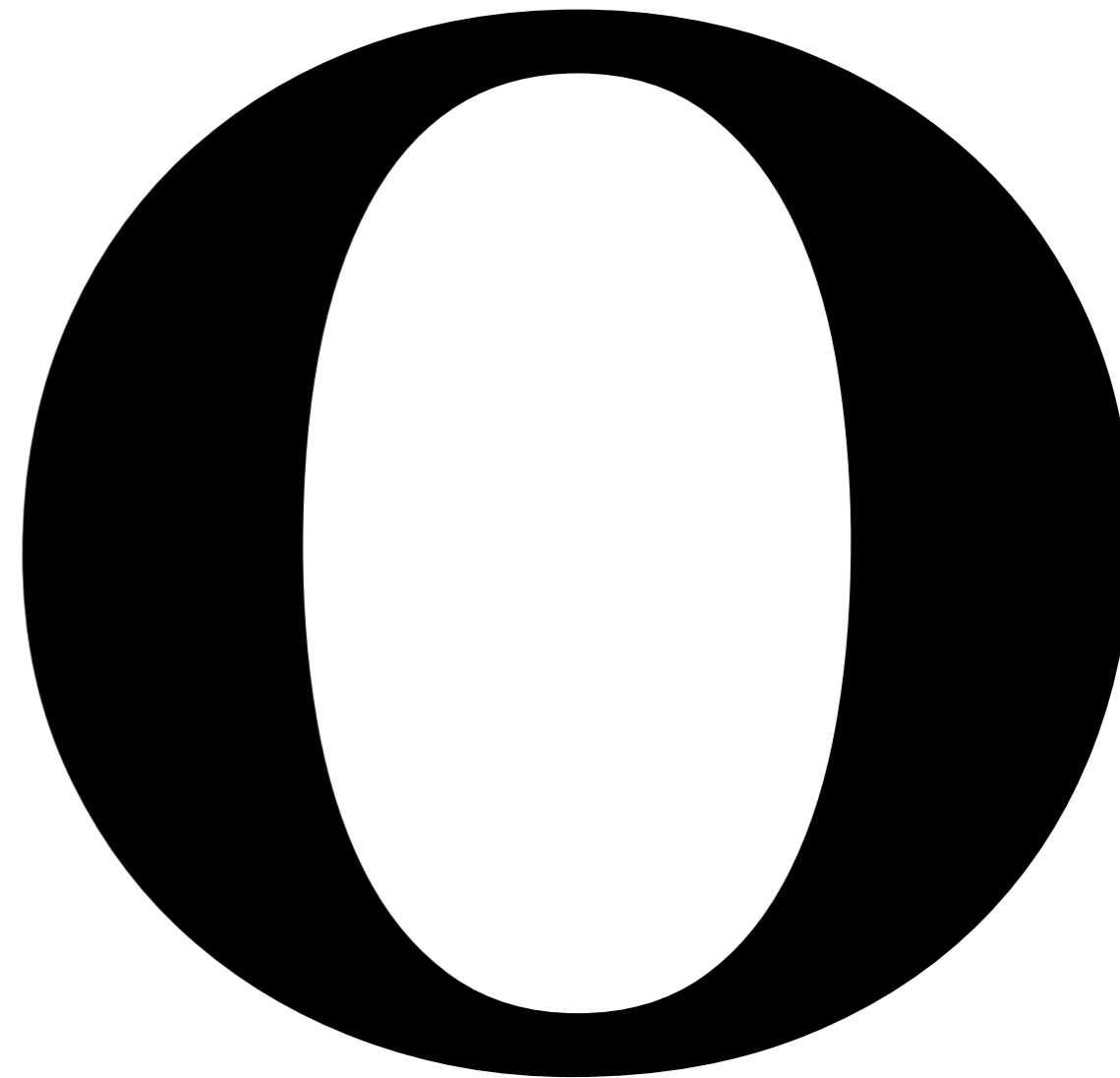
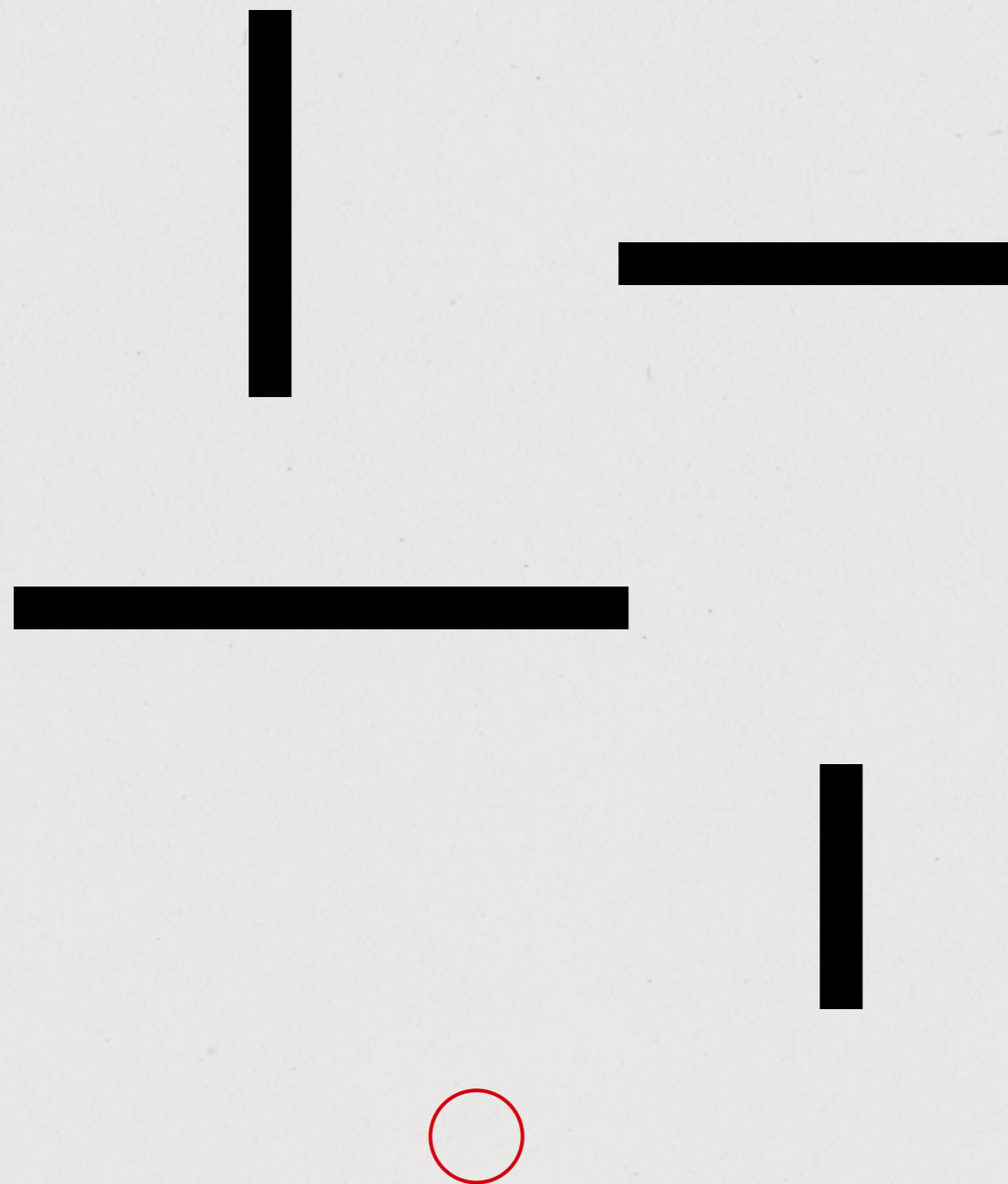

**Office
Collection**

Fino a non molti anni fa, ogni pezzo di arredo in un ufficio aveva una sua precisa funzione e il lavoro era scandito da ritmi e tempi regolari e ripetitivi. Sulle scrivanie erano appoggiate le macchine da scrivere sostituite poi dai computer e da ingombranti monitor. I contenitori e gli armadi erano pieni di carta e faldoni. I tavoli riunioni erano gli unici elementi "inabitati" e mettevano di conseguenza un po' di soggezione. Oggi che l'hardware sta nella tasca di una giacca e il software segue di conseguenza, che il lavoro è diventato fluido senza rigide costrizioni di orari, che le riunioni sono sempre più frequenti e sempre più "operative". Quali potrebbero essere i requisiti individuabili negli elementi di arredo dello spazio di lavoro? Probabilmente la loro funzione primaria deve essere quella di armonizzare gli spazi del lavoro con la vita delle persone. In questo catalogo presentiamo una collezione dedicata all'ambiente ufficio pensata in questo senso.

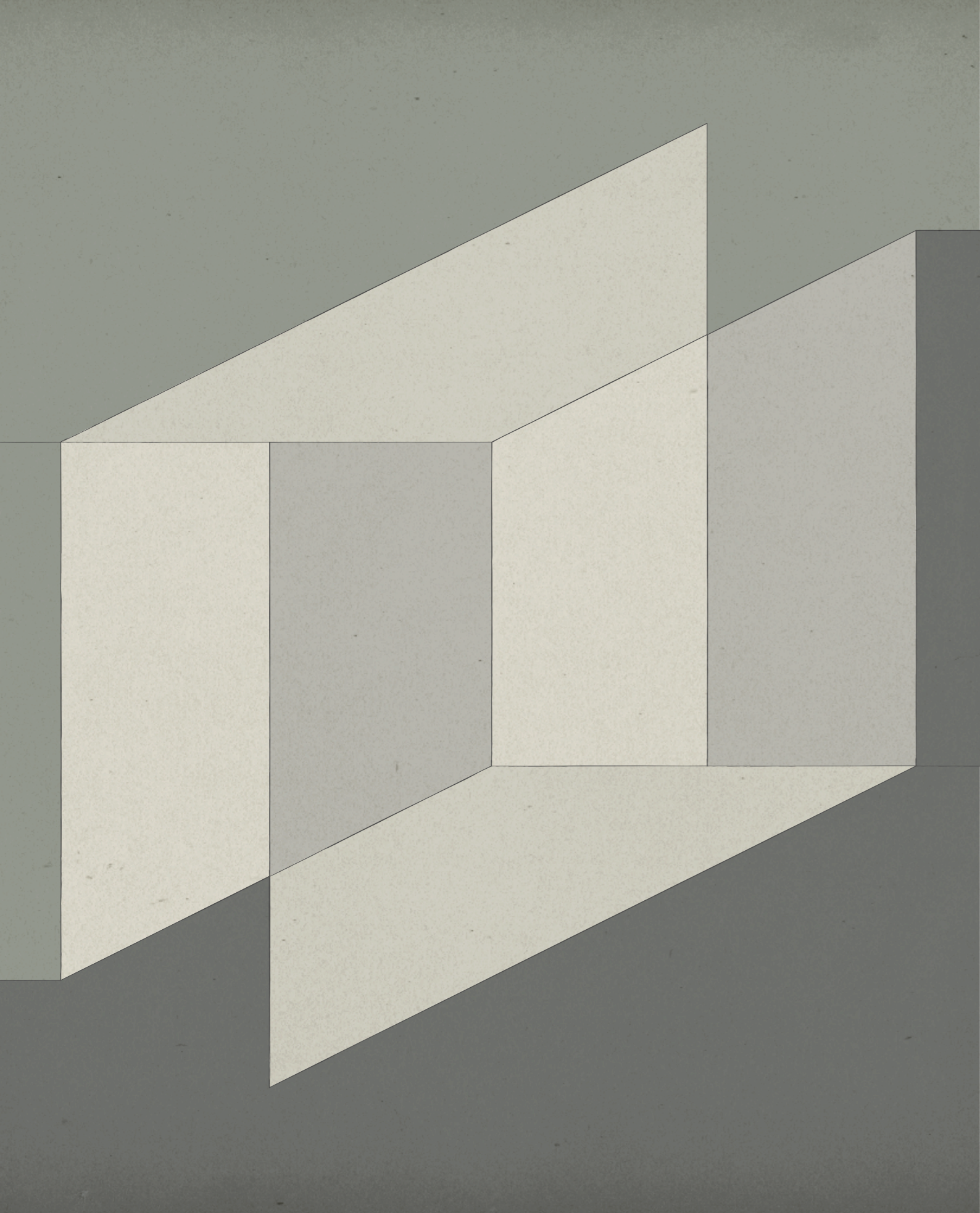

Not so long ago, each piece of furniture in an office had its own specific function and the work was remarked by regular and recurring times. On desks, were typewriters, then replaced by computers and bulky monitors.

Cabinets and closets were full of paper and boxes.

Meeting tables were the only empty elements and, consequently, they instilled apprehension. Today, technology and software stay in the pocket of a jacket, work has become fluid without strict constrictions in time and meetings are more and more frequent and efficient.

Therefore, what could be the requirements of the furnishing elements of the office?

Probably, their primary function has to be that of harmonizing workplaces with people's lives.

Following this idea, in this catalogue we introduce you to a complete collection, dedicated to office environments.

1

**Tavoli riunione/
Conference tables/
Tables de conférence/
Konferenztische**

10 Akim
14 Akim System
18 Carlomagno
22 Dolm System
28 Koy
34 Lord
38 Raj / Raj Light
40 Raj 4 / Raj 4 Light
42 WGS

2

**Sedute/
Seatings/
Sièges/
Sitzelemente**

46 OFX 09
48 WGS Stool

3

**Scrivanie/
Desks/
Bureaux/
Schreibtische**

52 Air Desk
56 Air Desk Console
58 Air Desk 1
68 Air Desk 1 Up/1 Up S
78 Air Desk Hall
82 Air Desk L
84 Air Desk Modesty
90 Air Desk W
92 Milano / Milano 1
96 President Scrivania / Dattilo
100 President Junior / Senior
102 WGS
106 WGS Double
110 Zen

4

**Cassettiere/
Drawer units/
Bloc tiroirs/
Rollcontainer**

114 Air Drawer/Air Drawer 3
116 Movie Cassettiera
118 President Cassettiera
120 Techna 13

5

**Accessori/
Accessories/
Accessories/
Accessories/**

124 Air Pad
124 Cover Cable Plate 1,2
126 Cover Cable Plate 3
126 Glass Pad
126 Mouse Pad
128 Snake
128 Sottomano
128 WGS Glove
130 WGS Screen

6

**Contentitori/
Storage Units/
Meubles/
Sideboards**

134 Air Unit
142 Air Up
148 Air Up Shelf
150 Air Wheel
152 Erminia

Tavoli riunione/ Conference tables/ Tables de conférence/ Konferenztische

10	Akim
14	Akim System
18	Carlomagno
22	Dolm System
28	Koy
34	Lord
38	Raj/Raj Light
40	Raj 4/Raj 4 Light
42	WGS

Akim

Tavolo con piano in cristallo extralight 15mm, retroverniciato solo nella parte centrale, nei colori del campionario, nella versione brillante. Basi in legno rivestito in cristallo 6mm temperato retroverniciato. Su richiesta può essere dotato di sistema passacavi. Akim si presta per composizioni modulari, anche in dimensioni speciali (Akim System).

Table with 15mm extralight glass top, painted only in the middle part, as per samples in the bright version. Wooden base covered by 6mm tempered painted glass. Available with cable management, on request. Akim is suitable for modular compositions also in customised sizes (Akim System).

Table avec plateau en verre extralight de 15mm d'épaisseur, verni seulement au milieu dans les coloris de nos échantillons dans la version brillante. Piètement en bois recouvert de verre de 6mm d'épaisseur trempé verni. Sur demande disponible avec système pour le passage des câbles. Akim est destiné à des compositions modulables aussi en dimensions spéciales (Akim System).

Tisch: Glasplatte Extralight 15mm, in der Mitte hochglanz nach Musterkarte lackiert. Gestell Holz mit vorgespanntem lackiertem Glas 6mm umkleidet. Auf Wunsch lieferbar auch mit Kabeldurchlass. Akim kann in modularer Weise, auch in Sondermassen verwendet werden (Akim System).

p. 11 **Tavolo con piano in cristallo extralight da 320x120 cm e parte centrale retroverniciata blu grigio brillante. Base rivestita in cristallo retroverniciato blu grigio brillante.**

Table with 320x120 cm extralight glass top and bright blue grey painted middle part. Base covered by bright blue grey painted glass.

Table avec plateau en verre transparent de 320x120 cm et partie centrale vernie blue gris brillant. Piètement recouvert en verre verni blue gris brillant.

Tisch mit Glasplatte klar Extralight 320x120 cm und in der Mitte Glas blau grau hochglänzend lackiert. Gestell mit blau grau hochglänzendem Glas umkleidet.



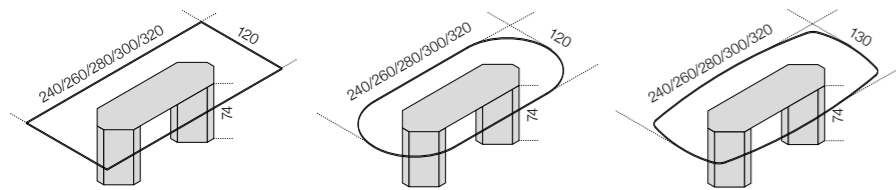

Cm (L x P x H)	Inches (W x D x H)
240 x 120 x 74	94½" x 47¼" x 29¼"
260 x 120 x 74	102½" x 47¼" x 29¼"
280 x 120 x 74	110½" x 47¼" x 29¼"
300 x 120 x 74	118½" x 47¼" x 29¼"
320 x 120 x 74	126" x 47¼" x 29¼"
240 x 130 x 74	94½" x 51¼" x 29¼"
260 x 130 x 74	102½" x 51¼" x 29¼"
280 x 130 x 74	110½" x 51¼" x 29¼"
300 x 130 x 74	118½" x 51¼" x 29¼"
320 x 130 x 74	126" x 51¼" x 29¼"

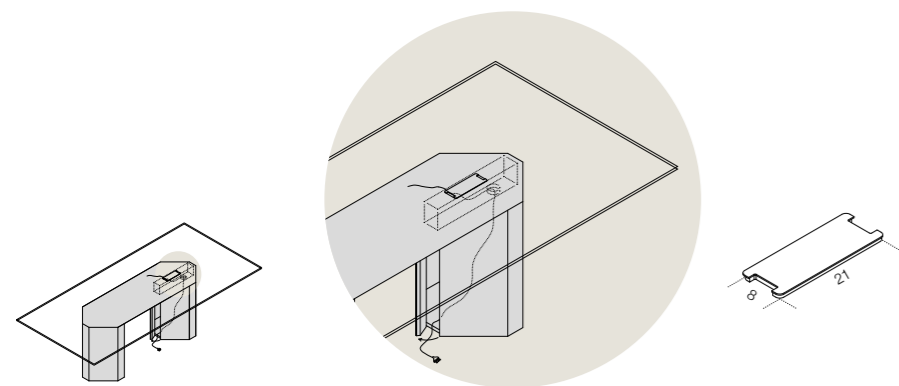

Akim System

Sistema modulare di tavoli con piani in cristallo extralight 15mm, retroverniciati solo nella parte centrale, nei colori del campionario, nella versione brillante. Basi in legno rivestito in cristallo 6mm temperato retroverniciato. Si possono realizzare composizioni in dimensioni speciali. Su richiesta puo'essere dotato di sistema passacavi.

Modular system of tables with 15mm extralight glass tops, painted only in the middle part, as per samples in the bright version. Wooden base covered by 6mm tempered painted glass. Customised compositions on request. Available with cable management, on request.

Composition modulable de tables avec plateaux en verre extralight de 15mm d'épaisseur, vernis seulement au milieu dans les coloris de nos échantillons dans la version brillante. Piètement en bois recouvert de verre de 6mm d'épaisseur trempé verni. Il est possible de réaliser des compositions en dimensions spéciales. Sur demande disponible avec système pour le passage des câbles.

Tischezusammenstellung in modularer Weise: Glasplatte Extralight 15mm, in der Mitte hochglanz nach Musterkarte lackiert. Gestell Holz mit vorgespanntem lackiertem Glas 6mm umkleidet. Zusammenstellungen in Sondermassen möglich. Auf Wunsch lieferbar auch mit Kabeldurchlass.

pp. 15, 16-17

Composizione di tavoli 600x120x74h cm con piani in cristallo trasparente extralight e parte centrale retroverniciata blu grigio brillante. Dotato di sistema passacavi. Base rivestita in cristallo retroverniciato blu grigio brillante. Sedie OFX 09 h85 cm in pelle scamosciata Sand 006. Lampada Bolle in altezza speciale.

Tables composition 600x120x74h cm with extralight transparent glass tops and bright blue grey painted middle part. Supplied with cable management. Base covered by bright blue grey painted glass. Chairs OFX09 h85 cm in suede Sand 006. Lamp Bolle with special height.

Composition de tables 600x120x74h cm avec plateaux en verre transparent extralight et partie centrale vernie blue gris brillant. Avec système pour le passage des câbles. Piètement recouvert en verre verni blue gris brillant. Chaises OFX 09 h85 cm en suédine Sand 006. Lampe Bolle avec hauteur spéciale.

Tischezusammenstellung 600x120x74h cm mit Glasplatte klar Extralight und in der Mitte Glas blau hochglänzend lackiert. Mit Kabeldurchlass. Gestell mit blau grau hochglänzendem Glas umkleidet. Stühle OFX 09 h85 cm Wildleder Sand 006. Lampe Bolle in Sonderhöhe.

Cm (L x P x H)

440 x 120 x 74
480 x 120 x 74
520 x 120 x 74
560 x 120 x 74
600 x 120 x 74
640 x 120 x 74

Inches (W x D x H)

173¼" x 47¼" x 29¼"
189" x 47¼" x 29¼"
204¾" x 47¼" x 29¼"
220½" x 47¼" x 29¼"
236¼" x 47¼" x 29¼"
252" x 47¼" x 29¼"

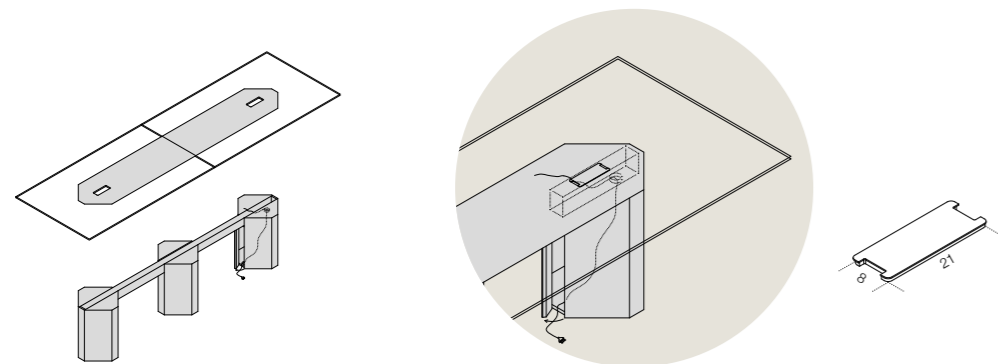
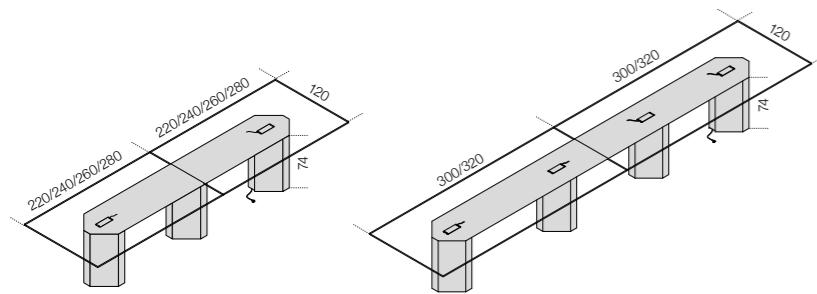



Carlomagno

Tavolo con piano in cristallo trasparente 15mm. A richiesta retroverniciato nei colori del campionario, nella versione brillante o satinata. Struttura in acciaio inox lucido (profilo 40x20x2mm). Disponibile anche in acciaio inox satinato o in acciaio laccato bianco o nero goffrato. Per le versioni XL da 260x110 cm il piano è sempre in cristallo trasparente 19mm. Struttura (profilo 50x25x3mm) in acciaio inox lucido o satinato. Su richiesta si realizzano piani con dimensioni speciali.

Table with 15mm transparent glass top. Painted glass as per samples in the bright or satin version, on request. Structure in bright stainless steel (40x20x2mm). Also available in satin stainless steel or embossed white or black lacquered steel. For the XL versions, from 260x110cm, the top is always in 19mm transparent glass. Bright or satin stainless steel structure (50x25x3mm). Customised sizes for the top on request.

Table avec plateau en verre transparent de 15mm d'épaisseur. Sur demande aussi en verre verni dans les coloris de nos échantillons dans la version brillante ou satinée. Structure en acier inox brillant (40x20x2mm). Disponible aussi en acier inox satiné ou en acier laqué blanc ou noir gaufré. Pour les versions XL, à partir de 260x110cm, le plateau est toujours transparent de 19mm d'épaisseur. Structure (50x25x3mm) en acier inox brillant ou satiné. Sur demande il est possible de réaliser plateaux en dimensions spéciales.

Tisch: Glasplatte 15mm klar. Glas lieferbar auch nach Musterkarte lackiert. Lackierung jeweils hochglanz oder matt satiniert. Gestell Edelstahl (Inox) poliert (Profilmasse 40x20x2mm). Auf Wunsch auch Edelstahl (Inox) gebürstet oder weiss oder schwarz strukturlackiert. Für die XL-Ausführungen, ab 260x110cm, ist die Glasplatte immer klar 19mm. Gestell (Profilmasse 50x25x3 mm) Edelstahl (Inox) poliert oder gebürstet. Auf Anfrage Glasplatte auch in Sondergrößen lieferbar.

pp. 19, 20-21

Tavolo con piano in cristallo trasparente da 240x100 cm e struttura in acciaio inox lucido.

Table with 240x100 cm transparent glass top and bright stainless steel structure.

Table avec plateau en verre transparent de 240x100 cm et structure en acier inox brillant.

Tisch mit Klarglasplatte 240x100 cm und Gestell aus Edelstahl (Inox) poliert.

Carlomagno

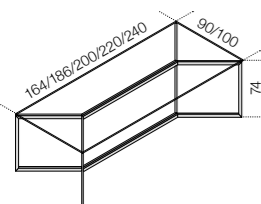

Carlomagno XL

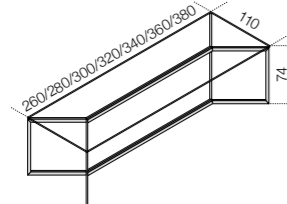

Glass	mm	Inches	Cm (L x P x H)	Inches (W x D x H)
15	6"	6"	164 x 90 x 74	64 ³ / ₄ " x 35 ¹ / ₂ " x 29 ¹ / ₄ "
15	6"	6"	186 x 90 x 74	73 ³ / ₄ " x 35 ¹ / ₂ " x 29 ¹ / ₄ "
15	6"	6"	200 x 100 x 74	78 ³ / ₄ " x 39 ¹ / ₂ " x 29 ¹ / ₄ "
15	6"	6"	220 x 100 x 74	86 ³ / ₄ " x 39 ¹ / ₂ " x 29 ¹ / ₄ "
15	6"	6"	240 x 100 x 74	94 ¹ / ₂ " x 39 ¹ / ₂ " x 29 ¹ / ₄ "
19	7 ¹ / ₂ "	7 ¹ / ₂ "	260 x 110 x 74	102 ¹ / ₂ " x 43 ¹ / ₂ " x 29 ¹ / ₄ "
19	7 ¹ / ₂ "	7 ¹ / ₂ "	280 x 110 x 74	110 ¹ / ₄ " x 43 ¹ / ₂ " x 29 ¹ / ₄ "
19	7 ¹ / ₂ "	7 ¹ / ₂ "	300 x 110 x 74	118 ¹ / ₄ " x 43 ¹ / ₂ " x 29 ¹ / ₄ "
19	7 ¹ / ₂ "	7 ¹ / ₂ "	320 x 110 x 74	126" x 43 ¹ / ₂ " x 29 ¹ / ₄ "
19	7 ¹ / ₂ "	7 ¹ / ₂ "	340 x 110 x 74	134" x 43 ¹ / ₂ " x 29 ¹ / ₄ "
19	7 ¹ / ₂ "	7 ¹ / ₂ "	360 x 110 x 74	141 ³ / ₄ " x 43 ¹ / ₂ " x 29 ¹ / ₄ "
19	7 ¹ / ₂ "	7 ¹ / ₂ "	380 x 110 x 74	149 ³ / ₄ " x 43 ¹ / ₂ " x 29 ¹ / ₄ "





Dolm System

Sistema modulare di tavoli con piani in cristallo extralight 15mm, retroverniciati solo nella parte centrale nei colori del campionario nella versione brillante. Piano con bisello alternato a 45°. Basi in legno rivestito in cristallo 6mm temperato retroverniciato. Si possono realizzare composizioni in dimensioni speciali. Su richiesta puo' essere dotato di sistema passacavi.

Modular system of tables with 15mm extralight glass tops, painted only in the middle part as per samples in the bright version. 45° alternated bevelled glass top. Wood in base covered by 6mm tempered painted glass as per samples. Customised compositions on request. Available with cable management, on request.

Composition modulable de tables avec plateaux en verre extralight de 15mm d'épaisseur, vernis seulement au milieu dans les coloris de nos échantillons dans la version brillante. Plateau biseauté alterné à 45°. Piètement en bois recouvert de verre de 6mm d'épaisseur trempé verni. Il est possible de réaliser des compositions en dimensions spéciales. Sur demande disponible avec système pour le passage des câbles..

Tischezusammenstellung in modularer Weise: Glasplatte Extralight 15mm, in der Mitte hochglanz nach Musterkarte lackiert. Glas mit 45° abwechselnd Facettschliff. Gestell Holz mit vorgespanntem lackiertem Glas 6mm umkleidet. Zusammenstellungen in Sondermassen möglich. Auf Wunsch lieferbar auch mit Kabeldurchlass.

pp. 24-25

Composizione di tavoli 400x120x74h cm con piani in cristallo trasparente extralight bisellato e parte centrale retroverniciata grigio beige brillante. Base rivestita in cristallo retroverniciato grigio beige brillante. Dotato di sistema passacavi. Sedie OFX 09 h85 cm in pelle scamosciata Sand 012. Composizione Air Unit pensile da 362x51x74h cm (tre moduli U02R da 120 cm) rivestita in cristallo grigio beige satinato. Tic Tac 14 orologio tinto tabacco.

Tables composition 400x120x74h cm with extralight transparent bevelled glass tops and bright taupe painted middle part. Base covered by bright taupe painted glass. Supplied with cable management. Chairs OFX 09 h85 cm in suede Sand 012. Air Unit suspended composition 362x51x74h cm (three units U02R of 120 cm) covered by satin taupe painted glass. Tic Tac 14 clock tobacco stained.

Composition de tables 400x120x74h cm avec plateaux en verre transparent extralight biseauté et partie centrale verni taupe brillant. Avec système pour le passage des câbles. Piètement recouvert en verre verni taupe brillant. Chaises OFX 09 h85 cm en suède Sand 012. Composition murale Air Unit de 362x51x74h cm (trois meubles U02R de 120 cm) recouvert de verre verni taupe satiné. Tic tac 14 horloge teinté tabac.

Tischezusammenstellung 400x120x74h cm mit Glasplatte klar Extralight mit Facettschliff und in der Mitte Glas beige-grau hochglänzend lackiert. Mit Kabeldurchlass. Gestell mit beige-grau hochglänzendem Glas umkleidet. Stühle OFX 09 h85 cm Wildleder Sand 012. Hänge-Komposition Air Unit 362x51x74h cm (drei Elementen U02R 120 cm) mit beige-grau matt satiniertem lackiertem Glas umkleidet. Tic Tac 14 Pendeluhr Tabakfarbe gebeizt.





Cm (L x P x H)	Inches (W x D x H)
400 x 110 x 74	157½" x 43½" x 29¼"
460 x 110 x 74	181¼" x 43½" x 29¼"
540 x 110 x 74	212¾" x 43½" x 29¼"
580 x 110 x 74	228½" x 43½" x 29¼"
640 x 110 x 74	252" x 43½" x 29¼"
760 x 110 x 74	299¼" x 43½" x 29¼"

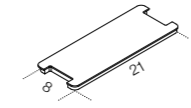
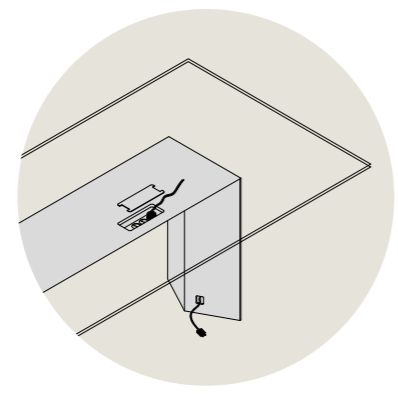
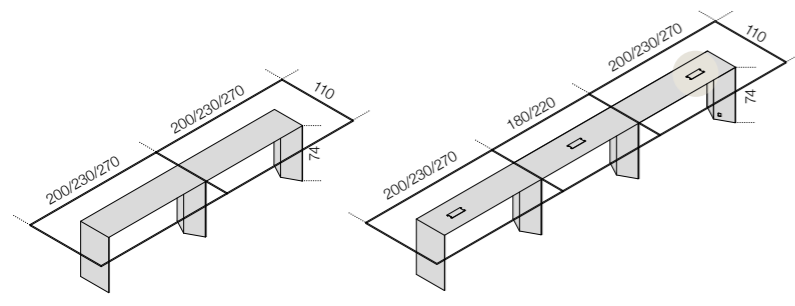

Koy

Tavolo con struttura in alluminio rivestito in rovere tinto tabacco o tinto wengé. Disponibile anche laccato bianco o nero goffrato o laccato effetto tessuto nei colori castagna, sabbia e canapa. Piano in cristallo trasparente o "grigio Italia" 12mm. Su richiesta retroverniciato nei colori del campionario nella versione brillante o satinata. Su richiesta puo' essere dotato di sistema passacavi.

Table with aluminium structure covered by tobacco stained or wengé stained oak. Available also with embossed white or black lacquered structure or "fabric" touch effect lacquered structure in the chestnut, sand and canapa colours. 12mm transparent or smoked "grigio Italia" glass top. Painted glass as per samples in the bright or satin version, on request. Available with cable management, on request.

Table avec structure en aluminium recouvert de chêne teinté tabac ou teinté wengé. Disponible aussi laqué blanc ou noir gaufré ou laqué avec effet tissu dans les coloris châtaigne, sablé ou chanvre. Plateau en verre transparent ou "grigio Italia" fumé de 12mm d'épaisseur. Sur demande verni dans les coloris de nos échantillons dans la version brillante ou satinée. Sur demande disponible avec système pour le passage des câbles.

Tisch: Aluminiumgestell mit Eiche Tabakfarbe oder Wengé gebeizt umkleidet. Lieferbar auch weiss oder schwarz strukturlackiert oder lackiert mit Stoff-Effekt in kastanienbraun, sandfarben und hanffarben. Glasplatte klar oder Rauchglas "grigio Italia" 12mm. Auf Wunsch Glas nach Musterkarte lackiert. Lackierung jeweils hochglanz oder matt satiniert. Der Tisch kann mit Kabeldurchlass geliefert werden.





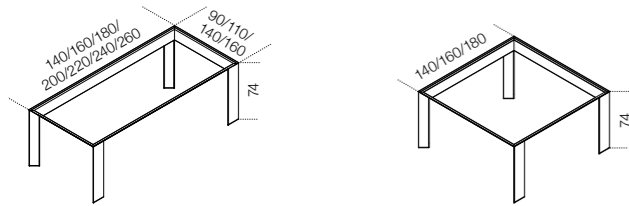

Cm (L x P x H)

140 x 90 x 74

160 x 90 x 74

180 x 90 x 74

200 x 90 x 74

220 x 90 x 74

140 x 110 x 74

160 x 110 x 74

180 x 110 x 74

200 x 110 x 74

220 x 110 x 74

240 x 110 x 74

260 x 110 x 74

160 x 140 x 74

180 x 140 x 74

180 x 160 x 74

140 x 140 x 74

160 x 160 x 74

180 x 180 x 74

Inches (W x D x H)

55 1/4" x 35 1/2" x 29 1/4"

63" x 35 1/2" x 29 1/4"

71" x 35 1/2" x 29 1/4"

78 3/4" x 35 1/2" x 29 1/4"

86 3/4" x 35 1/2" x 29 1/4"

55 1/4" x 43 1/2" x 29 1/4"

63" x 43 1/2" x 29 1/4"

71" x 43 1/2" x 29 1/4"

78 3/4" x 43 1/2" x 29 1/4"

86 3/4" x 43 1/2" x 29 1/4"

94 1/2" x 43 1/2" x 29 1/4"

102 1/2" x 43 1/2" x 29 1/4"

63" x 55 1/4" x 29 1/4"

71" x 55 1/4" x 29 1/4"

71" x 63" x 29 1/4"

55 1/4" x 55 1/4" x 29 1/4"

63" x 63" x 29 1/4"

71" x 71" x 29 1/4"

CANALIZZAZIONE
CABLE MANAGEMENT
SYSTÈME POUR LE PASSAGE DES CÂBLES
KABELMANAGEMENT

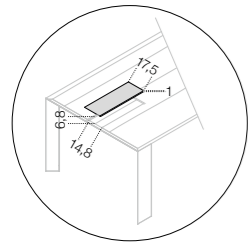

Il tavolo può essere dotato di sistema passacavi con vano ispezionabile e piani removibili in legno nello stesso colore della struttura.

The table can be equipped with a cable management with an inspectable unit with removable wooden shelves in the same colour of the structure.

La table peut être disponible avec système pour le passage des câbles avec un espace accessible et plateaux amovibles en bois dans le même couleur de la structure.

Der Tisch kann mit einem Kabelkanal ausgestattet werden, der über, in den gleichen Tischfarben, eingesetzte Holzböden zugänglich ist.

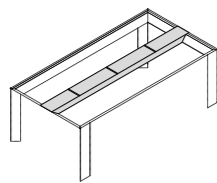

Canalizzazione centrale per tavolo con profondità minima cm 140 e per tavolo riunione profondità minima cm 110.

Central cable management for table cm 140 min. deep and for conference table cm 110 min. deep.

Système pour le passage des câbles au milieu de la table 140 cms profondeur minime et de la table de conférence 110cms profondeur minime.

Kabeldurchführung in der Mitte für Tisch cm 140 Mindesttiefe und für Konferenztisch cm 110 Mindesttiefe.

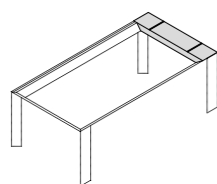

Canalizzazione laterale per tavolo.

Side cable management for table.

Système pour le passage des câbles au côté de la table.

Seitenkabeldurchführung für Tisch.



Lord

Tavolo con piano in cristallo trasparente 15mm. A richiesta retroverniciato nei colori del campionario, nella versione brillante o satinata. Struttura in acciaio inox lucido (profilo 40x20x2mm). Disponibile anche in acciaio inox satinato o in acciaio laccato bianco o nero gofrato. Per le versioni XL da 260x110 cm il piano è sempre in cristallo trasparente 19mm. Struttura in acciaio inox lucido o satinato. Su richiesta si realizzano piani con dimensioni speciali.

Table with 15mm transparent glass top. Painted glass as per samples in the bright or satin version, on request. Structure in bright stainless steel (40x20x2mm). Available also in satin stainless steel or embossed white or black lacquered steel. For the XL versions, from 260x110 cm, the top is always in 19mm transparent glass. Bright or satin stainless steel structure (50x25x3mm). Customised sizes for the top on request.

Table avec plateau en verre transparent de 15mm d'épaisseur. Sur demande aussi en verre verni dans les coloris de nos échantillons dans la version brillante ou satinée. Structure en acier inox brillant (40x20x2mm). Disponible aussi en acier inox satiné ou en acier laqué blanc ou noir gaufré. Pour les versions XL, à partir de 260x110cms, le plateau est toujours transparent de 19mm d'épaisseur. Structure (50x25x3mm) en acier inox brillant ou satiné. Sur demande il est possible de réaliser plateaux en dimensions spéciales.

Tisch: Glasplatte 15mm klar. Glas lieferbar auch nach Musterkarte lackiert. Lackierung jeweils hochglanz oder matt satiniert. Gestell Edelstahl (Inox) poliert (Profilmasse 40x20x2mm). Auf Wunsch auch Edelstahl (Inox) gebürstet oder weiss oder schwarz strukturlackiert. Für die XL Ausführungen, ab 260x110 cm, ist die Glasplatte immer klar 19mm. Gestell (Profilmasse 50x25x3mm) Edelstahl (Inox) poliert oder gebürstet. Auf Anfrage Glasplatte auch in Sondergrößen lieferbar.

Lord

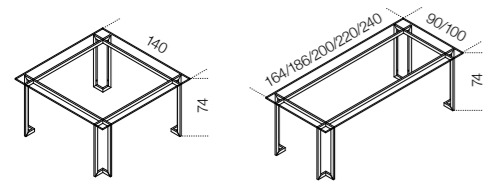

Lord XL

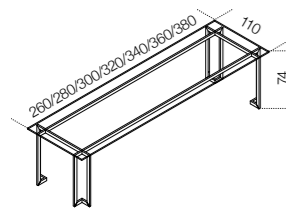

Glass	mm	Inches	Cm (L x P x H)	Inches (W x D x H)
15	6"		140 x 140 x 74	55¼" x 55¼" x 29¼"
15	6"		164 x 90 x 74	64¾" x 35½" x 29¼"
15	6"		186 x 90 x 74	73¾" x 35½" x 29¼"
15	6"		200 x 100 x 74	78¾" x 39½" x 29¼"
15	6"		220 x 100 x 74	86¾" x 39½" x 29¼"
15	6"		240 x 100 x 74	94½" x 39½" x 29¼"
19	7½"		260 x 110 x 74	102½" x 43½" x 29¼" XL
19	7½"		280 x 110 x 74	110¼" x 43½" x 29¼"
19	7½"		300 x 110 x 74	118¼" x 43½" x 29¼"
19	7½"		320 x 110 x 74	126" x 43½" x 29¼"
19	7½"		340 x 110 x 74	134" x 43½" x 29¼"
19	7½"		360 x 110 x 74	141¾" x 43½" x 29¼"
19	7½"		380 x 110 x 74	149¾" x 43½" x 29¼"





Raj / Raj Light

Raj	Tavolo con piano in cristallo trasparente. Struttura in acciaio inox lucido completa di pannellatura in lastra d'acciaio lucido. Giunto centrale in alluminio cromato.	Table with transparent glass top. Bright stainless steel base with bright steel insert. Chromed aluminium central joint.	Table avec plateau en verre transparent. Piètement en acier inox brillant avec panneau en acier brillant. Joint en aluminium chromé.	Tisch mit Glasplatte klar. Fussgestell Edelstahl (Inox) poliert mit Stahlblechfüllung hochglänzend poliert. Zentralverbindungselement in Aluminium verchromt.
Raj Light	<p>Tavolo con piano in cristallo trasparente. Struttura in acciaio inox lucido. Giunto centrale in alluminio cromato.</p> <p>p. 39 Tavolo con piano in cristallo trasparente da 320x120 cm (a biscotto) e struttura in acciaio inox lucido.</p>	<p>Table with transparent glass top. Bright stainless steel base. Chromed aluminium central joint.</p> <p>Table with 320x120 cm (racecourse shape) transparent glass top and bright stainless steel structure.</p>	<p>Table avec plateau en verre transparent. Structure en acier inox brillant. Joint en aluminium chromé.</p> <p>Table avec plateau en verre transparent de 320x120 cm (en forme de hippodrome) et piètement en acier inox brillant.</p>	<p>Tisch mit Glasplatte klar. Fussgestell Edelstahl (Inox) poliert. Zentralverbindungselement in Aluminium verchromt.</p> <p>Tisch mit Klarglasplatte 320x120 cm (Pferderennbahnförmig) und Fussgestell aus Edelstahl (Inox) poliert.</p>

Raj

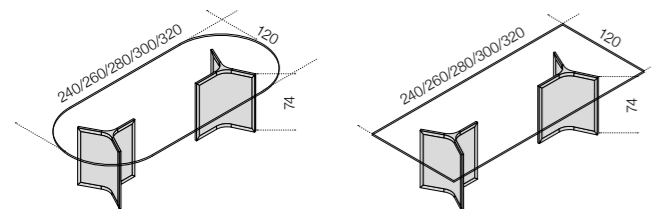

Glass	mm	Inches	Cm (L x P x H)	Inches (W x D x H)
15	6"		240 x 120 x 74	94½" x 47¼" x 29¼"
15	6"		260 x 120 x 74	102½" x 47¼" x 29¼"
19	7½"		280 x 120 x 74	110¼" x 47¼" x 29¼"
19	7½"		300 x 120 x 74	118¼" x 47¼" x 29¼"
19	7½"		320 x 120 x 74	126" x 47¼" x 29¼"

Raj Light

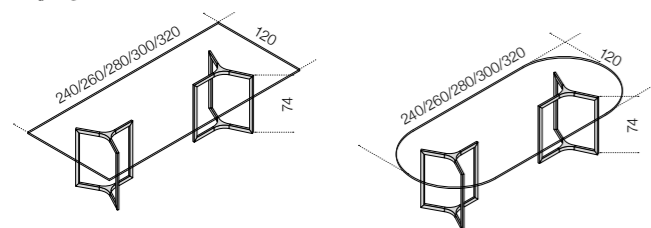

Raj 4 / Raj 4 Light

Raj 4

Tavolo mono base con giunto centrale in alluminio cromato e piano in cristallo trasparente 15mm. Struttura in acciaio inox lucido completa di pannellatura in lastra d'acciaio lucido.

Table with one base with chromed aluminium central joint and 15mm transparent glass top. Bright stainless steel base with bright steel insert.

Table avec un seul piètement avec joint central en aluminium chromé et plateau en verre transparent de 15mm d'épaisseur. Piètement en acier inox brillant avec panneau en acier brillant.

Tisch mit einem Fussgestell mit Zentralverbindungselement Aluminium verchromt und Glasplatte klar 15mm. Fussgestell Edelstahl (Inox) poliert mit Stahlblechfüllung hochglänzend.

Raj 4 Light

Tavolo mono base con giunto centrale in alluminio cromato e piano in cristallo trasparente 15mm. Struttura in acciaio inox lucido.

Table with one base with chromed aluminium central joint and 15mm transparent glass top. Bright stainless steel base.

Table avec un seul piètement avec joint central en aluminium chromé et plateau en verre transparent de 15mm d'épaisseur. Piètement en acier inox brillant.

Tisch mit einem Fussgestell mit Zentralverbindungselement Aluminium verchromt und Glasplatte klar 15mm. Fussgestell Edelstahl (Inox) poliert.

p. 41

Tavolo con piano in cristallo trasparente da 210 x130 cm (ovale) e struttura con pannellatura in acciaio inox lucido.

Table with 210x130 cm (oval) transparent glass top and bright stainless steel structure with insert.

Table avec plateau en verre transparent de 210 x130 cm (oval) et piètement avec panneau en acier inox brillant.

Tisch mit Klarglasplatte 210x130 cm (Oval) und Fussgestell mit Stahlblechfüllung aus Edelstahl (Inox) poliert.

Raj 4

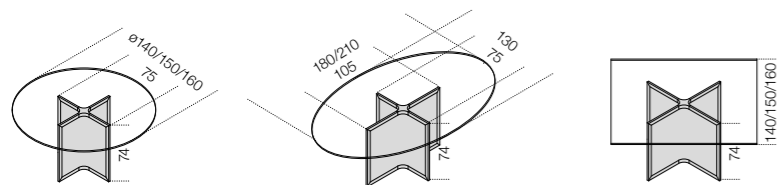

Cm (L x P x H)

ø 140 x 74
ø 150 x 74
ø 160 x 74
180 x 130 x 74
210 x 130 x 74
140 x 140 x 74
150 x 150 x 74
160 x 160 x 74

Inches (W x D x H)

○ ø 55¼" x 29¼"
○ ø 59¼" x 29¼"
○ ø 63" x 29¼"
○ 71" x 51¼" x 29¼"
○ 82¾" x 51¼" x 29¼"
□ 55¼" x 55¼" x 29¼"
□ 59¼" x 59¼" x 29¼"
□ 63" x 63" x 29¼"

Raj 4 Light

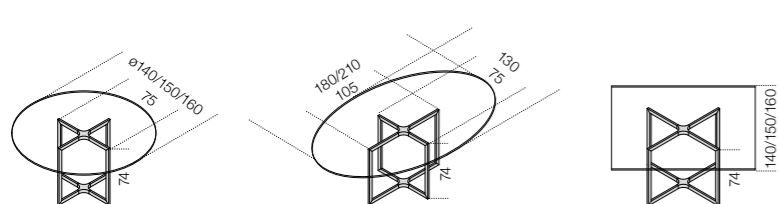

WGS

Tavolo con piano in cristallo trasparente o "grigio Italia" temperato 12mm. A richiesta retroverniciato nei colori del campionario nella versione brillante o satinata. Base in rovere spazzolato naturale, tinto wengé, laccato bianco o nero a poro aperto. Parti metalliche in acciaio inox lucido.

Table with 12mm transparent or smoked "grigio Italia" tempered glass top. Painted glass as per sample in the bright or satin version, on request. Brushed natural oak, wengé stained, white or black open pore lacquered base. Bright stainless steel metal parts.

Table avec plateau en verre transparent ou "grigio Italia" fumé trempé de 12mm d'épaisseur. Sur demande aussi en verre verni dans les coloris de nos échantillons dans la version brillante ou satinée. Piètement en chêne naturel brossé, teinté wengé, laqué blanc ou noir pores ouverts. Parties métalliques en acier inox brillant.

Tisch: Glasplatte vorgespannt klar oder Rauchglas "grigio Italia" 12mm. Glas lieferbar auch nach Musterkarte lackiert. Lackierung jeweils hochglanz oder matt satiniert. Gestell Eiche natur gebürstet, Wengé gebeizt, weiss oder schwarz lackiert offenporig. Metallteile Edelstahl (Inox) poliert.

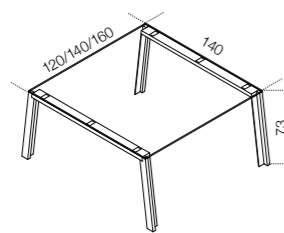
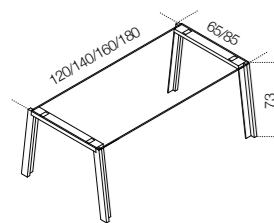
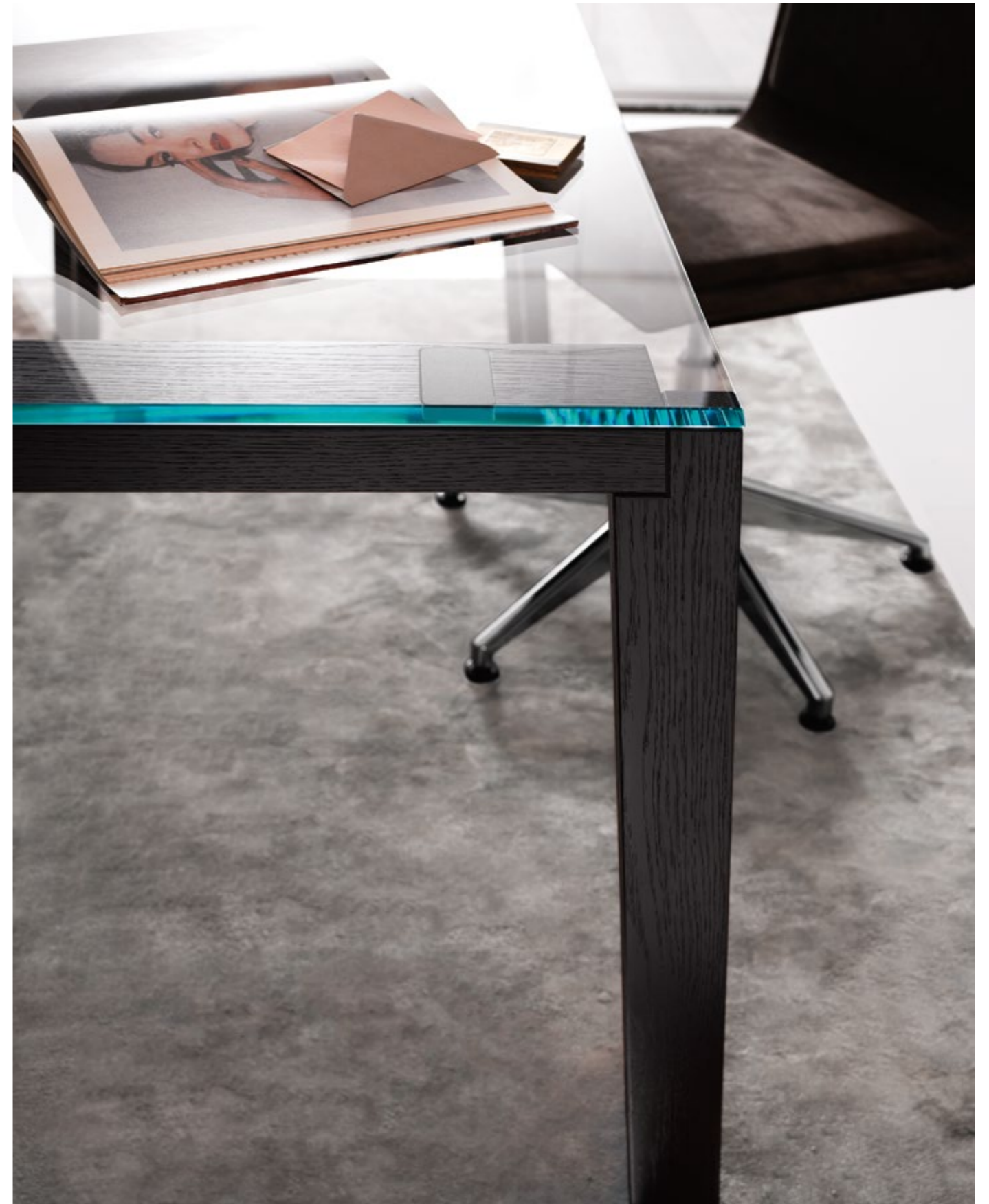

Cm (L x P x H)

120 x 65 x 73
140 x 65 x 73
160 x 65 x 73
140 x 85 x 73
160 x 85 x 73
180 x 85 x 73
120 x 140 x 73
140 x 140 x 73
160 x 140 x 73

Inches (W x D x H)

47 $\frac{1}{4}$ " x 25 $\frac{3}{4}$ " x 28 $\frac{3}{4}$ "
55 $\frac{1}{4}$ " x 25 $\frac{3}{4}$ " x 28 $\frac{3}{4}$ "
63" x 25 $\frac{3}{4}$ " x 28 $\frac{3}{4}$ "
55 $\frac{1}{4}$ " x 33 $\frac{1}{2}$ " x 28 $\frac{3}{4}$ "
63" x 33 $\frac{1}{2}$ " x 28 $\frac{3}{4}$ "
71" x 33 $\frac{1}{2}$ " x 28 $\frac{3}{4}$ "
47 $\frac{1}{4}$ " x 55 $\frac{1}{4}$ " x 28 $\frac{3}{4}$ "
55 $\frac{1}{4}$ " x 55 $\frac{1}{4}$ " x 28 $\frac{3}{4}$ "
63" x 55 $\frac{1}{4}$ " x 28 $\frac{3}{4}$ "



**Sedute/
Seatings/
Sièges/
Sitzelemente**

46 OFX09
48 WGSStool

OFX 09

Sedia ufficio ergonomica. Seduta con scocca in legno imbottito e rivestito in pelle scamosciata o ecopelle nei colori del campionario. Schienale in 3 diverse altezze. Base girevole a 5 razze in alluminio pressofuso dotato di elevazione a gas, con ruote o finalini. Disponibile con braccioli cromati.

Ergonomic office chair. Upholstered wooden seat covered with suede or ecoleather as per samples. 3 different heights for backrest. Swivel five-star base made of die-cast aluminium. Gas lift height adjustment, with castors or feet. Available with chromed armrests.

Siège de bureau ergonomique. Assise en bois rembourrée et revêtue de simili cuir ou suédine dans les coloris de nos échantillons. Dossier à 3 positions de hauteurs différentes. Base pivotante à 5 pieds en aluminium moulé sous pression, système d'élévation à gaz, avec roulettes ou pieds. Disponible avec accoudoirs chromés.

Ergonomischer Bürostuhl. Sitz aus Holz gepolstert und mit Wildleder oder Spaltleder nach Musterkarte bezogen. Verstellbare Rückenlehne in 3 unterschiedlichen Höhen. Höhenverstellung mit Gasdruckfeder und Dreh-Kreuzgestell mit 5 Rollen oder Füßchen. Auf Wunsch mit verchromten Armlehnen.

p. 47 Sedia ufficio 85h cm in pelle scamosciata Sand 006.

Office chair 85h cm in suede Sand 006.

Chaise de bureau 85h cm en suédine Sand 006.

Bürostuhl 85h cm Wildleder Sand 006.

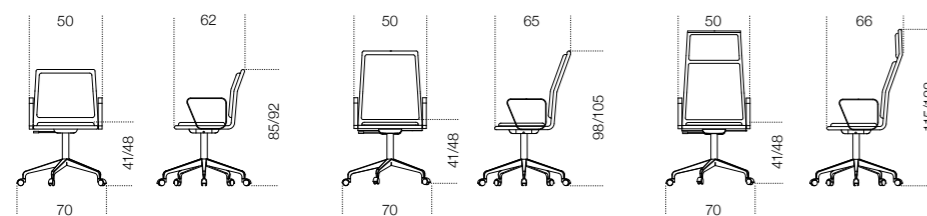

Cm (L x P x H)

50 x 62 x 85/92
50 x 65 x 98/105
50 x 66 x 115/122

Inches (W x D x H)

19¾" x 24½" x 33½"/36¼"
19¾" x 25¾" x 38¾"/41½"
19¾" x 26" x 45½"/48¼"



WGS Stool

Sgabello in acciaio inox lucido oppure in metallo laccato bianco goffrato, grigio alluminio o color ottone satinato rivestito in pelle scamosciata o velluto nei colori del campionario. Prodotto non disponibile con interliner.

Bright stainless steel or embossed white, grey aluminium or satin brass colour lacquered metal stool, covered by suede or velvet as per samples. Product not available with interliner.

Tabouret en acier inox brillant ou en métal laqué blanc gaufré, gris aluminium ou couleur laiton satiné recouvert suédine ou velours dans les coloris de nos échantillons. Product non disponible avec interliner.

Hocker aus Edelstahl (Inox) poliert oder Metall Lack weiss strukturlackiert, Aluminium grau oder Messing-Farbe satiniert, mit Wildleder oder Samt bezogen. Lieferbare Farben nach Musterkarte. Produkt nicht mit Interliner verfügbar.

p. 49 Sgabelli in ottone satinato rivestiti in pelle scamosciata Sand 006 e Grey 058.

Satin brass stools covered by suede Sand 006 and Grey 058.

Tabourettes en laiton satiné recouvert de suédine Sand 006 et Grey 058.

Hocker aus satiniertem Messing, bezogen mit Wildledersand 006 und Grau 058.



Cm (L x P x H)
45 x 30 x 45

Inches (W x D x H)
17¾" x 12" x 17¾"

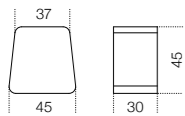

Scrivanie/ Desks/ Bureaux/ Schreibtische

52	Air Desk
56	Air Desk Console
58	Air Desk 1
68	Air Desk 1 Up / 1 UPS
78	Air Desk Hall
82	Air Desk L
84	Air Desk Modesty
90	Air Desk W
92	Milano / Milano 1
96	President Scrivania / Dattilo
100	President Junior / Senior
102	WGS
106	WGS Double
110	Zen

Air Desk

Scrivania in cristallo trasparente, extralight o "grigio Italia" temperato 12mm. Disponibile con piano retroverniciato nei colori del campionario nella versione brillante o satinata oppure in cristallo laminato effetto pelle. Su richiesta spalle retroverniciate nei colori del campionario nella versione brillante o satinata. Parti metalliche in acciaio inox lucido, satinato oppure alluminio anodizzato o laccato bianco o nero goffrato. Su richiesta alluminio spazzolato a mano anodizzato nei colori nero o titanio. Per consentire il passaggio dei cavi è possibile richiedere una foratura nel piano oppure il passaggio, degli stessi, attraverso la trave e uscita dal tappo laterale. (vedi pag. 36). Distanza minima dal bordo: 10cm.

Desk in 12mm transparent, extralight or smoked "grigio Italia" tempered glass. Also available with painted glass top as per samples in the bright or satin version, or leather effect laminated glass top. Sides available in painted glass as per samples in the bright or satin version, on request. Bright or satin stainless steel, anodised aluminium or embossed white or black lacquered metal parts. Hand brushed aluminium in the colours black or titanium grey, on request. For a proper cable management, a hole on the top can be arranged upon request, or cables can pass through the beam to be pulled out from one side (see page 36). Minimum distance from the edge: 10cm.

Bureau en verre transparent, extralight ou "grigio Italia" fumé trempé de 12mm d'épaisseur. Disponible aussi avec plateau en verre verni dans les coloris de nos échantillons dans la version brillante ou satinée, ou en verre revêtu effet cuir. Sur demande, côtés en verre verni dans les coloris de nos échantillons dans la version brillante ou satinée. Parties métalliques en acier inox brillant, satiné ou en aluminium anodisé, laqué blanc ou noir gaufré. Sur demande aluminium brossé à la main dans les coloris noir ou gris titane. Pour permettre le passage des câbles un trou peut être réalisé dans le plateau, ou les câbles peuvent passer dans la poutre et sortir par un côté (voir page 36). Distance minimum du bord: 10cm.

Schreibtisch: Glas vorgespant klar, Extralight oder Rauchglas "grigio Italia" 12mm. Glasplatte und Glasseiten lieferbar auch nach Musterkarte lackiert. Lackierung jeweils hochglanz oder matt satiniert. Auf Wunsch Glasplatte mit Leder-Effekt umkleidet. Metallteile Edelstahl (Inox) poliert, gebürstet oder eloxiertes Aluminium oder weiss oder schwarz strukturlackiert. Lieferbar auch Aluminium handgebürstet in den Farben schwarz oder titan grau. Für die Kabelführung kann eine Bohrung in der Glasplatte vorgesehen werden. Die Kabel können zudem durch den hohlen Balken geführt werden, entweder durch eine Bohrung auf der Oberseite des Balkens unterhalb der Bohrung in der Glasplatte oder durch einen Auslass in der stirnseitigen Abdeckung des Balkens. (siehe Seite 36). Mindestabstand von der Kante: 10cm.

p. 53, 54-55

Scrivania in cristallo trasparente extralight da 200x90x74h cm e parti metalliche in acciaio inox lucido. Sedia OFX 09 h115 cm in pelle scamosciata Sand 012. Boiserie Elle Plus 10 da 481x28,5x140h cm rivestita in cristallo retroverniciato champagne satinato. Composizione Air Unit pensile da 482x35x36 cm rivestita in cristallo retroverniciato champagne satinato.

Extralight transparent glass desk 200x90x74h cm and bright stainless steel metal parts. Chair OFX 09 h115 cm in suede Sand 012. Elle Plus 10 boiserie 481x28,5x140h cm covered by satin champagne painted glass. Air Unit suspended composition 482x35x36 cm covered by satin champagne painted glass.

Bureau en verre transparent extralight de 200x90 x74h cm et parties métalliques en acier inox brillant. Chaise OFX 09 h115 cm en suédine Sand 012. Elle Plus 10 boiserie de 481x28,5x140h cm recouvert de verre verni champagne satiné. Composition murale Air Unit de 482x35x36 cm recouverte de verre verni champagne satiné.

Schreibtisch aus Glas klar Extralight von 200x90 x74h cm und Metallteile Edelstahl (Inox) poliert. Stuhl OFX 09 h115 cm Wildleder Sand 012. Elle Plus 10 Boiserie 481x28,5 x140h cm mit champagne matt satiniertem Glas umkleidet. Hänge-Komposition Air Unit 482x35 x36 cm mit champagne matt satiniertem Glas umkleidet.

Cm (L x P x H)

120 x 51 x 74
140 x 51 x 74
160 x 51 x 74
120 x 80 x 74
140 x 80 x 74
160 x 80 x 74
180 x 90 x 74
200 x 90 x 74
120 x 120 x 74
140 x 120 x 74
160 x 120 x 74
180 x 120 x 74
200 x 120 x 74
180 x 206 x 74
200 x 206 x 74

Inches (W x D x H)

47¼" x 20¾" x 29¾"
55¼" x 20¾" x 29¾"
63" x 20¾" x 29¾"
47¼" x 31½" x 29¾"
55¼" x 31½" x 29¾"
63" x 31½" x 29¾"
71" x 35½" x 29¾"
78¾" x 35½" x 29¾"
47¼" x 47¼" x 29¾"
55¼" x 47¼" x 29¾"
63" x 47¼" x 29¾"
71" x 47¼" x 29¾"
78¾" x 47¼" x 29¾"
71" x 81¼" x 29¾"
78¾" x 81¼" x 29¾"

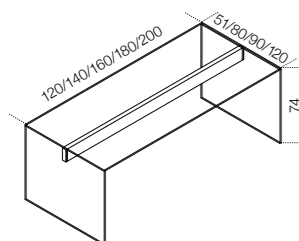



Air Desk Console

Consolle in cristallo trasparente, extralight o "grigio Italia" temperato 12mm. Disponibile con piano retroverniciato nei colori del campionario nella versione brillante o satinata. A richiesta piano in cristallo laminato effetto pelle. Su richiesta spalle retroverniciate nei colori del campionario nella versione brillante o satinata. Parti metalliche in acciaio inox lucido, satinato oppure alluminio anodizzato o laccato bianco o nero goffrato. Su richiesta alluminio spazzolato a mano nei colori nero o titanio.

Console in 12mm transparent, extralight or smoked "grigio Italia" tempered glass. Available also with painted glass top as per samples in the bright or satin version. Leather effect laminated glass top, on request. Sides available in painted glass as per samples in the bright or satin version, on request. Bright or satin stainless steel, anodized aluminium or embossed white or black lacquered metal parts. Hand brushed aluminium in the colours black or titanium grey, on request.

Console en verre transparent, extralight ou «grigio Italia» fumé trempé de 12mm d'épaisseur. Disponible aussi avec plateau en verre verni dans les coloris de nos échantillons dans la version brillante ou satinée. Sur demande plateau en verre revêtu effet cuir. Sur demande, côtés en verre verni dans les coloris de nos échantillons dans la version brillante ou satinée. Parties métalliques en acier inox brillant, satiné ou en aluminium anodisé, laqué blanc ou noir gaufré. Sur demande aluminium brossé à la main dans les coloris noir ou gris titane.

Konsole: Glas vorgespannt klar, Extralight oder Rauchglas „grigio Italia“ 12mm. Glasplatte und Glasseiten lieferbar auch nach Musterkarte lackiert. Lackierung jeweils hochglanz oder matt satiniert. Auf Wunsch Glasplatte mit Leder-Effekt umkleidet. Metallteile Edelstahl (Inox) poliert, gebürstet oder eloxiertes Aluminium oder weiss oder schwarz strukturlackiert. Lieferbar auch Aluminium handgebürstet in den Farben schwarz oder titangrau.

p. 57 Consolle in cristallo trasparente extralight da 160x51x74h cm e parti metalliche in acciaio inox lucido. Cassettiera Air Drawer in cristallo retroverniciato champagne satinato. Sedia OFX 09 h85 cm in pelle scamosciata Sand 012.

Extralight transparent glass console 160x51x74h cm and bright stainless steel metal parts. Air Drawer covered by satin champagne painted glass. Chair OFX 09 h85 cm in suede Sand 012.

Console en verre transparent extralight de 160x51x74h cm et parties métalliques en acier inox brillant. Air Drawer bloc tiroir recouvert de verre verni champagne satiné. Chaise OFX 09 h85 cm en suède Sand 012.

Konsole aus Glas klar Extralight von 160x51x74h cm und Metallteile Edelstahl (Inox) poliert. Air Drawer Rollcontainer mit champagne matt satiniertem Glas umkleidet. Stuhl OFX 09 h85 cm Wildleder Sand 012.

Cm (L x P x H)

120 x 51 x 74
140 x 51 x 74
160 x 51 x 74

Inches (W x D x H)

47¼" x 20¾" x 29¾"
55¼" x 20¾" x 29¾"
63" x 20¾" x 29¾"

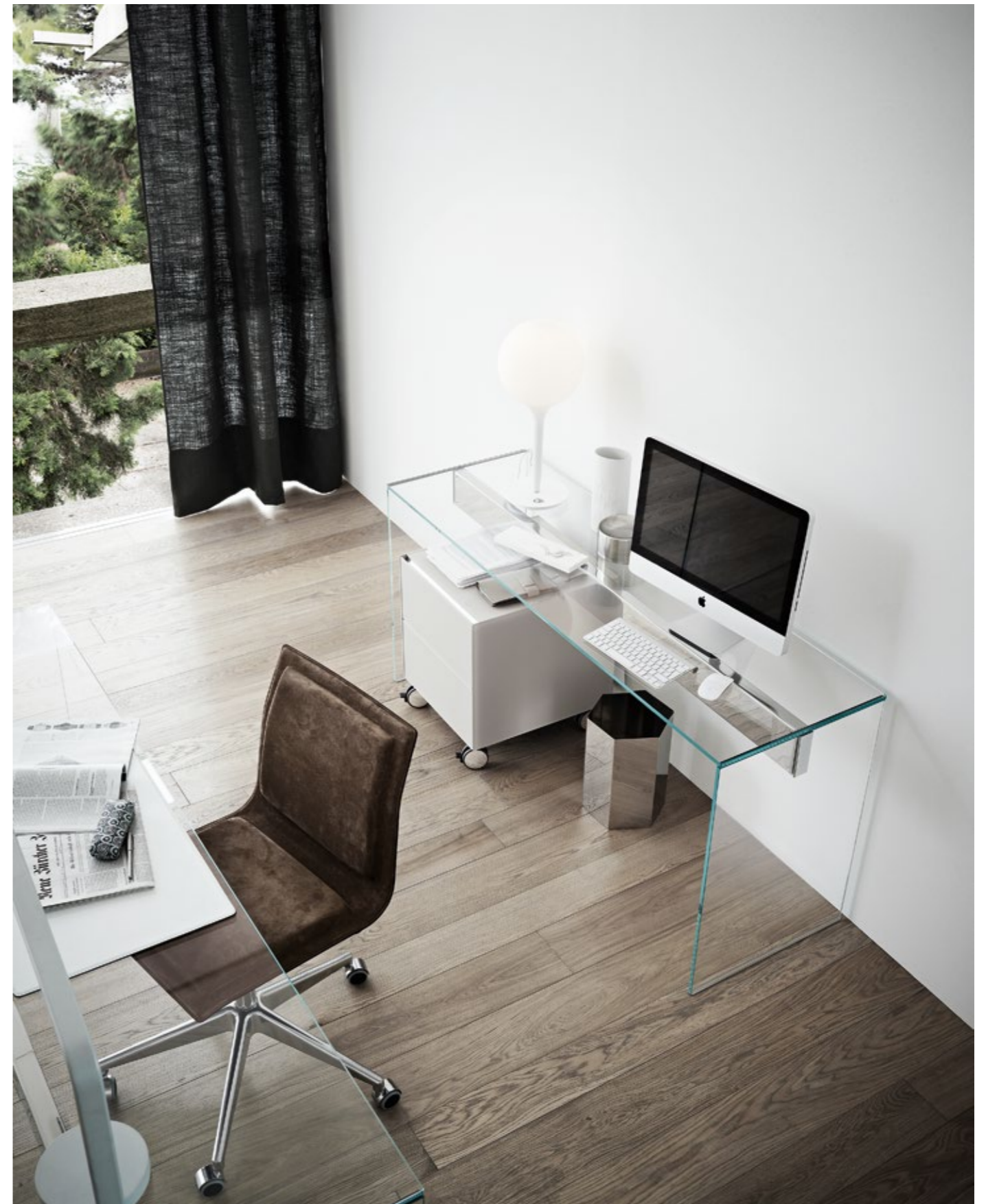
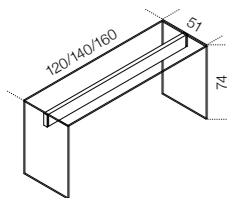

Air Desk 1

Scrivania in appoggio su sistema Air Unit in cristallo trasparente, extralight o "grigio Italia" temperato 12mm. Disponibile con piano retroverniciato nei colori del campionario nella versione brillante o satinata oppure in cristallo laminato effetto pelle. Su richiesta spalle retroverniciate nei colori del campionario nella versione brillante o satinata. Parti metalliche in acciaio inox lucido, satinato oppure alluminio anodizzato, laccato bianco o nero goffrato. Su richiesta alluminio spazzolato a mano anodizzato nei colori nero o titanio. Per consentire il passaggio dei cavi è possibile richiedere una foratura nel piano oppure il passaggio, degli stessi, attraverso la trave e uscita dal tappo laterale. (vedi pag. 36). Distanza minima dal bordo: 10cm.

Desk with one side resting on Air Unit system in 12mm transparent, extralight or smoked "grigio Italia" tempered glass. Also available with painted glass top as per samples in the bright or satin version, or leather effect laminated glass top. Sides available in painted glass as per samples in the bright or satin version, on request. Bright or satin stainless steel, anodised aluminium or embossed white or black lacquered metal parts. Hand brushed aluminium in the colours black or titanium grey, on request. For a proper cable management, a hole on the top can be arranged upon request, or cables can pass through the beam to be pulled out from one side (see page 36). Minimum distance from the edge: 10cm.

Bureau avec un côté posé sur Air Unit système en verre transparent, extralight ou «grigio Italia» fumé trempé de 12mm d'épaisseur. Disponible aussi avec plateau en verre verni dans les coloris de nos échantillons dans la version brillante ou satinée, ou en verre revêtu effet cuir. Sur demande, côtés en verre verni dans les coloris de nos échantillons dans la version brillante ou satinée, ou en aluminium anodisé, laqué blanc ou noir gaufré. Sur demande aluminium brossé à la main dans les coloris noir ou gris titane. Pour permettre le passage des câbles un trou peut être réalisé dans le plateau, ou les câbles peuvent passer dans la poutre et sortir par un côté (voir page 36). Distance minimum du bord: 10cm.

Schreibtischkombination aufgesetzt auf Air Unit Element: Glas vorge-spannt klar, Extralight oder Rauchglas "grigio Italia" 12mm. Glasplatte und Glaseiten lieferbar auch nach Musterkarte lackiert. Lackierung jeweils hochglanz oder matt satiniert. Auf Wunsch Glasplatte mit Leder-Effekt umkleidet. Metallteile Edelstahl (Inox) poliert, gebürstet oder eloxiertes Aluminium oder weiss oder schwarz strukturlackiert. Lieferbar auch Aluminium handgebürstet in den Farben schwarz oder titangrau. Für die Kabelführung kann eine Bohrung in der Glasplatte vorgesehen werden. Die Kabel können zudem durch den hohlen Balken geführt werden, entweder durch eine Bohrung auf der Oberseite des Balkens unterhalb der Bohrung in der Glasplatte oder durch einen Auslass in der stirnseitigen Abdeckung des Balkens. (siehe Seite 36). Mindestabstand von der Kante: 10cm.

pp. 59 , 60-61

Composizione Air Unit da 365x51x60h cm rivestita in cristallo retroverniciato grigio beige satinato. Scrivania in appoggio in cristallo trasparente extralight da 200x90x74h cm e parti metalliche in acciaio inox lucido. Sedia OFX 09 h85 cm in pelle scamosciata Sand 06. Specchio Zeiss Mirror 104x6x92h cm con cornice laccata effetto tessuto color castagna.

Air Unit composition 365x51x60h cm covered by satin taupe painted glass. Extralight transparent glass desk with one side resting 200x90x74h cm and bright stainless steel metal parts. Chair OFX 09 h85 cm in suede Sand 06. Zeiss mirror 104x6x92h cm with chestnut with "fabric" touch effect lacquered frame.

Composition Air Unit 365x51x60h cm recouverte de verre verni taupe satiné. Bureau avec un côté posé, en verre transparent extralight de 200x90x74h cm et parties métalliques en acier inox brillant. Chaise OFX 09 h85 cm en suédine Sand 06. Miroir Zeiss Mirror 104 x6x92h cm avec cadre laqué châtaigne en effet tissu.

Komposition Air Unit 365 x51x60h cm mit beige-grau matt satiniertem Glas umkleidet. Schreibtisch aufgesetzt aus Glas klar Extralight von 200x90 x74h cm und Metallteile Edelstahl (Inox) poliert. Stuhl OFX 09 h85 cm Wildleder Sand 06. Spiegel Zeiss Mirror 104 x6x92h cm mit Rahmen kastanienbraun mit Stoff-Effekt lackiert.





Desks

La scrivania Air Desk 1 si posiziona sui moduli contenitori Air Unit, versione a spalla portante 60h cm.

The Air Desk 1 shall rest on Air Unit modules, free-standing version with 60h cm sides.

Le bureau Air Desk 1 se pose sur les meubles Air Unit, version sur pieds par spalles portantes 60h cm.

Der Schreibtisch Air Desk 1 soll auf Air Unit-Möbel, freistehende Komposition mit Seitenwangen 60h cm, gestellt werden.

Cm (L x P x H)

120 x 80 x 74
140 x 80 x 74
160 x 80 x 74
180 x 90 x 74
200 x 90 x 74
120 x 120 x 74
140 x 120 x 74
160 x 120 x 74
180 x 120 x 74
200 x 120 x 74

Inches (W x D x H)

47¼" x 31½" x 29¼"
55¼" x 31½" x 29¼"
63" x 31½" x 29¼"
71" x 35½" x 29¼"
78¾" x 35½" x 29¼"
47¼" x 47¼" x 29¼"
55¼" x 47¼" x 29¼"
63" x 47¼" x 29¼"
71" x 47¼" x 29¼"
78¾" x 47¼" x 29¼"

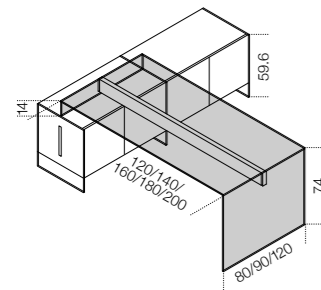

La scrivania Air Desk 1 si posiziona sui moduli contenitori Air Unit, nella versione pensile.

The Air Desk 1 shall rest on Air Unit modules, suspended version.

Le bureau Air Desk 1 se pose sur les meubles Air Unit, version murale.

Der Schreibtisch Air Desk 1 soll auf Air Unit-Möbel, Hänge-Komposition, gestellt werden.

Cm (L x P x H)

120 x 80 x 74
140 x 80 x 74
160 x 80 x 74
180 x 90 x 74
200 x 90 x 74
120 x 120 x 74
140 x 120 x 74
160 x 120 x 74
180 x 120 x 74
200 x 120 x 74

Inches (W x D x H)

47¼" x 31½" x 29¼"
55¼" x 31½" x 29¼"
63" x 31½" x 29¼"
71" x 35½" x 29¼"
78¾" x 35½" x 29¼"
47¼" x 47¼" x 29¼"
55¼" x 47¼" x 29¼"
63" x 47¼" x 29¼"
71" x 47¼" x 29¼"
78¾" x 47¼" x 29¼"

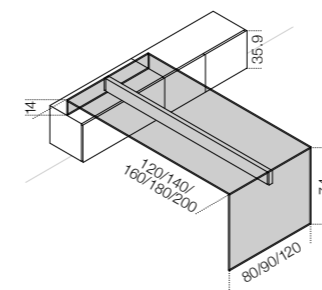

La scrivania Air Desk 1 con profondità 47 cm si posiziona sul mobile Air Unit nella modalità illustrata nel disegno.

The Air Desk 1 47 cm deep shall rest on Air Unit container as per drawing.

Le bureau Air Desk 1 prof. 47 cm se pose sur le meuble Air Unit selon le dessin.

Der Schreibtisch Air Desk 1 (Tiefe 47 cm) soll auf Air Unit Element wie die Skizze gestellt werden.

Cm (L x P x H)

120 x 47 x 74
140 x 47 x 74
160 x 47 x 74
180 x 47 x 74

Inches (W x D x H)

47¼" x 18¾" x 29¼"
55¼" x 18¾" x 29¼"
63" x 18¾" x 29¼"
71" x 18¾" x 29¼"

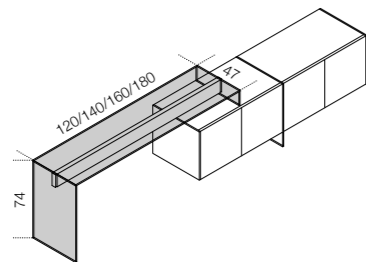
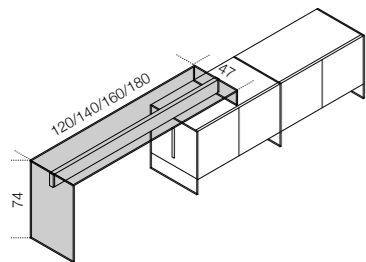

Moduli contenitori Air Unit h 35.9 cm per Air Desk 1.

Air Unit modules h 35.9 cm for Air Desk 1.

Meubles Air Unit h 35.9 cm pour Air Desk 1.

Air Unit-Möbel h 35.9 cm für Air Desk 1.

Cm (L x P x H)

90 x 34.1 x 35.9
120 x 34.1 x 35.9

Inches (W x D x H)

35½" x 20¼" x 14"
47¼" x 20¼" x 14"

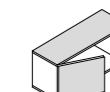
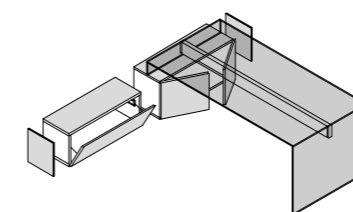

U06

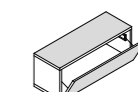

U06R

Moduli contenitori Air Unit h 45.1 cm per Air Desk 1.

Air Unit modules h 45.1 cm for Air Desk 1.

Meubles Air Unit h 45.1 cm pour Air Desk 1.

Air Unit-Möbel h 45.1 cm für Air Desk 1.

Cm (L x P x H)

90 x 51 x 45.1
120 x 51 x 45.1

Inches (W x D x H)

35½" x 20¼" x 18"
47¼" x 20¼" x 18"

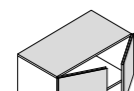
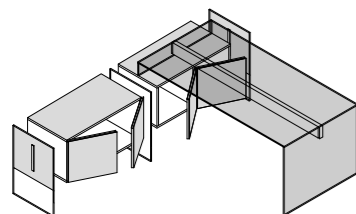

U01

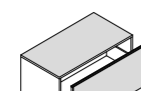

U02



U02X

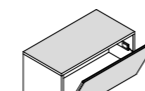

U02R

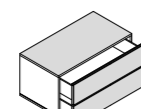

U03

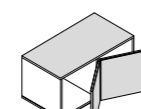

U04

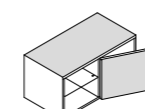

U05

Il sistema Air può essere abbinato alla boiserie Elle Plus 10.

The Air system can be matched with Elle Plus 10 boiserie.

Le système Air peut être joint à la boiserie Elle Plus 10.

Das System Air kann mit Boiserie Elle Plus 10 verbindet werden.

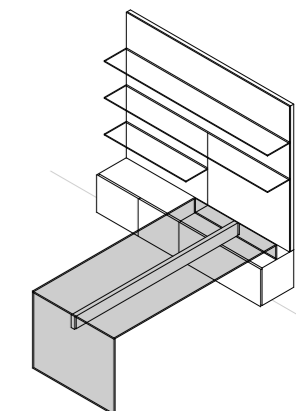



pp. 66-67 **Composizione Air Unit da 494x35x36h cm rivestita in cristallo specchiato "grigio Italia". Scrivania in appoggio in cristallo "grigio Italia" da 200x90x74h cm e parti metalliche in alluminio spazzolato nero. Elle Plus 10 Boiserie rivestita in tinto tabacco e cristallo specchiato "grigio Italia". Sedia OFX 09 h115 cm in pelle scamosciata Sand 012. Divano First in velluto blue 408. Tavolini Tetris.**

Air Unit composition 494 x35x36h cm covered by smoked "grigio Italia" mirrored glass. Smoked "grigio Italia" glass desk with one side resting 200x90 x74h cm and black brushed aluminium metal parts. Elle Plus 10 Boiserie covered by tobacco stained and smoked "grigio Italia" mirrored glass. Chair OFX 09 h115 cm in suede Sand 012. First sofa in blue 408 velvet. Tetris coffee tables.

Composition Air Unit 494 x35x36h cm recouverte de verre miroité "grigio Italia" fumé. Bureau avec un côté posé, en verre "grigio Italia" fumé de 200 x90x74h cm et parties métalliques en aluminium brossé noir. Elle Plus 10 Boiserie recouverte en teinté tabac et verre miroité "grigio Italia" fumé. Chaise OFX 09 h115 cm en suède Sand 012. Canapé First en velours blue 408. Tables basses Tetris.

Komposition Air Unit 494x35x36h cm mit "grigio Italia" Rauchglas umkleidet. Schreibtisch aufgesetzt aus "grigio Italia" Rauchglas von 200 x90x74h cm und Metallteile Aluminium schwarz handgebürstet. Elle Plus 10 Boiserie mit Tabakfarbe gebeizt und "grigio Italia" Rauchglas umkleidet. Stuhl OFX 09 h115 cm Wildleder Sand 012. Sofa First Samt blue 408. Couchtische Tetris.

Esempi di postazione lavoro con il sistema Air Desk 1 e Air Unit.

Examples of working stations using the Air Desk 1 and Air Unit system.

Exemples de working stations avec le système Air Desk 1 et Air Unit.

Beispiele der Arbeitsplätze mit Air Desk 1 und Air Unit System.

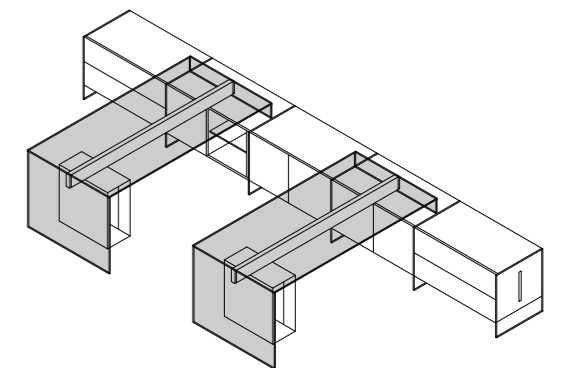
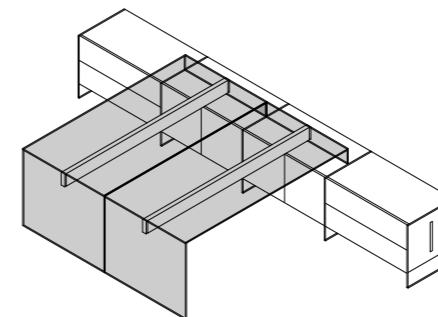
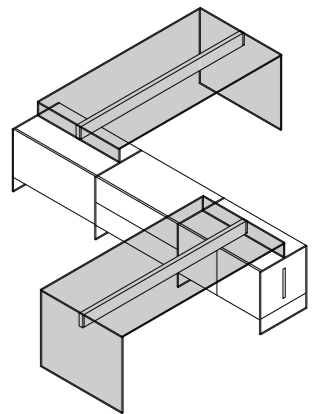
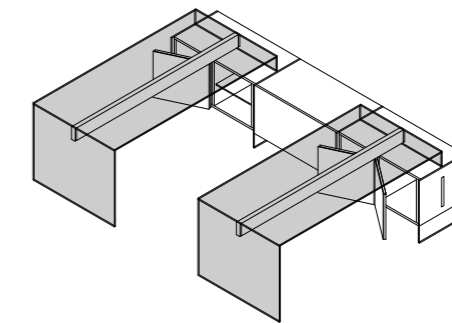
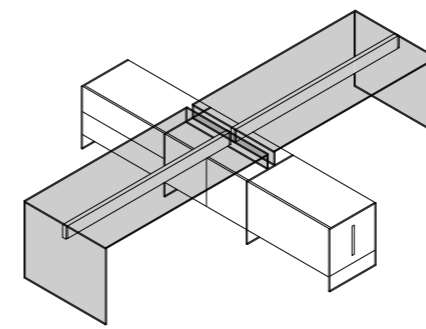



Air Desk 1 Up/1 Up S

Scrivania in appoggio su sistema Air Up in cristallo trasparente, extralight o "grigio Italia" temperato 12mm. Disponibile con piano retroverniciato nei colori del campionario nella versione brillante o satinata oppure in cristallo laminato effetto pelle. Su richiesta spalle retroverniciate nei colori del campionario nella versione brillante o satinata. Parti metalliche in acciaio inox lucido, satinato oppure alluminio anodizzato, laccato bianco o nero goffrato. Su richiesta alluminio spazzolato a mano anodizzato nei colori nero o titanio. Per consentire il passaggio dei cavi è possibile richiedere una foratura nel piano oppure il passaggio, degli stessi, attraverso la trave e uscita dal tappo laterale. (vedi pag. 36). Distanza minima dal bordo: 10cm.

Desk with one side resting on Air Up system in 12mm transparent, extralight or smoked "grigio Italia" tempered glass. Also available with painted glass top as per samples in the bright or satin version, or leather effect laminated glass top. Sides available in painted glass as per samples in the bright or satin version, on request. Bright or satin stainless steel, anodised aluminium or embossed white or black lacquered metal parts. Hand brushed aluminium in the colours black or titanium grey, on request. For a proper cable management, a hole on the top can be arranged upon request, or cables can pass through the beam to be pulled out from one side (see page 36). Minimum distance from the edge: 10cm.

Bureau avec un côté posé sur Air Up système en verre transparent, extralight ou "grigio Italia" fumé trempé de 12mm d'épaisseur. Disponible aussi avec plateau en verre verni dans les coloris de nos échantillons dans la version brillante ou satinée, ou en verre revêtu effet cuir. Sur demande, côtés en verre verni dans les coloris de nos échantillons dans la version brillante ou satinée. Parties métalliques en acier inox brillant, satiné ou en aluminium anodisé, laqué blanc ou noir gaufré. Sur demande aluminium brossé à la main dans les coloris noir ou gris titane. Pour permettre le passage des câbles un trou peut être réalisé dans le plateau, ou les câbles peuvent passer dans la poutre et sortir par un côté (voir page 36). Distance minimum du bord: 10cm.

Schreibtischkombination aufgesetzt auf Air Up Element: Glas vorgespannt klar, Extralight oder Rauchglas "grigio Italia" 12mm. Glasplatte und Glasseiten lieferbar auch nach Musterkarte lackiert. Lackierung jeweils hochglanz oder matt satiniert. Auf Wunsch Glasplatte mit Leder-Effekt umkleidet. Metallteile Edelstahl (Inox) poliert, gebürstet oder eloxiertes Aluminium oder weiss oder schwarz strukturlackiert. Lieferbar auch Aluminium handgebürstet in den Farbschwarz oder titangrau. Für die Kabelführung kann eine Bohrung in der Glasplatte vorgesehen werden. Die Kabel können zudem durch den hohlen Balken geführt werden, entweder durch eine Bohrung auf der Oberseite des Balkens unterhalb der Bohrung in der Glasplatte oder durch einen Auslass in der stirnseitigen Abdeckung des Balkens (siehe Seite 36). Mindestabstand von der Kante: 10cm.

pp. 69, 70-71

Composizione Air Up da 464x51x48,1h cm rivestita in cristallo retroverniciato visone brillante. Scrivanie in appoggio con piano laminato effetto pelle da 160x80x74h cm e parti metalliche in alluminio anodizzato. Sedie OFX 09 h85 cm in pelle scamosciata Sand 012.

Air Up Composition 464 x51x48,1h cm covered by bright mink painted glass. Desks with one side resting with leather effect laminated glass top 160x80 x74h cm and anodised aluminium metal parts. Chairs OFX 09 h85 cm in suede Sand 012.

Composition Air Up 464 x51x48,1h cm recouvert de verre verni vison brillant. Bureau avec un côté posé, avec plateau en verre revêtu effet cuir de 160x80 x74h cm et parties métalliques en aluminium anodisé. Chaises OFX 09 h85 cm en suédine Sand 012.

Komposition Air Up 464 x51x48,1h cm mit Nerzfarbe hochglänzendem Glas umkleidet. Schreibtisch aufgesetzt mit Glasplatte mit Leder-Effekt umkleidet von 160x80 x74h cm und Metallteile eloxiertes Aluminium. Stühle OFX 09 h85 cm Wildleder Sand 012.





Desks

				Cm (L x P x H)	Inches (W x D x H)
La scrivania Air Desk 1 Up si posiziona sui moduli contenitori Air Up.	The Air Desk 1 Up shall rest on Air Up modules.	Le bureau Air Desk 1 Up se pose sur les meubles Air Up.	Der Schreibtisch Air Desk 1 Up soll auf Air Up-Möbel, gestellt werden.	120 x 80 x 74 140 x 80 x 74 160 x 80 x 74 180 x 90 x 74 200 x 90 x 74 120 x 120 x 74 140 x 120 x 74 160 x 120 x 74 180 x 120 x 74 200 x 120 x 74	47¼" x 31½" x 29¼" 55¼" x 31½" x 29¼" 63" x 31½" x 29¼" 71" x 35½" x 29¼" 78¾" x 35½" x 29¼" 47¼" x 47¼" x 29¼" 55¼" x 47¼" x 29¼" 63" x 47¼" x 29¼" 71" x 47¼" x 29¼" 78¾" x 47¼" x 29¼"

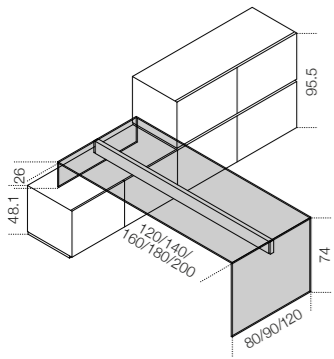

				Cm (L x P x H)	Inches (W x D x H)
La scrivania Air Desk 1 Up si posiziona sui moduli contenitori Air Up.	The Air Desk 1 Up shall rest on Air Up modules.	Le bureau Air Desk 1 Up se pose sur les meubles Air Up.	Der Schreibtisch Air Desk 1 Up soll auf Air Up-Möbel, gestellt werden.	120 x 80 x 74 140 x 80 x 74 160 x 80 x 74 180 x 90 x 74 200 x 90 x 74 120 x 120 x 74 140 x 120 x 74 160 x 120 x 74 180 x 120 x 74 200 x 120 x 74	47¼" x 31½" x 29¼" 55¼" x 31½" x 29¼" 63" x 31½" x 29¼" 71" x 35½" x 29¼" 78¾" x 35½" x 29¼" 47¼" x 47¼" x 29¼" 55¼" x 47¼" x 29¼" 63" x 47¼" x 29¼" 71" x 47¼" x 29¼" 78¾" x 47¼" x 29¼"

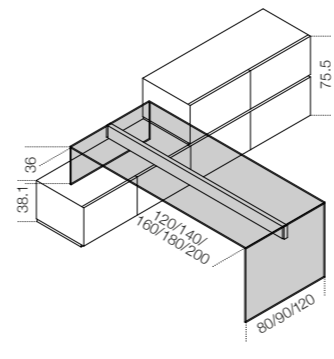

				Cm (L x P x H)	Inches (W x D x H)
La scrivania Air Desk 1 Up con profondità 47 cm si posiziona sul mobile Air Up nella modalità illustrata nel disegno.	The Air Desk 1 Up 47 cm deep shall rest on Air Up container as per above drawing.	Le bureau Air Desk 1 Up prof. 47 cm se pose sur le meuble Air Up selon dessin.	Der Schreibtisch Air Desk 1 Up (Tiefe 47 cm) soll auf Air Up Element wie die Skizze gestellt werden.	120 x 47 x 74 140 x 47 x 74 160 x 47 x 74 180 x 47 x 74	47¼" x 18¾" x 29¼" 55¼" x 18¾" x 29¼" 63" x 18¾" x 29¼" 71" x 18¾" x 29¼"

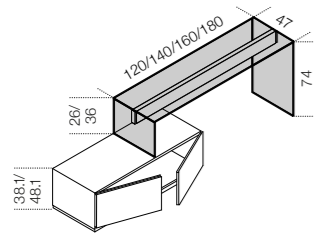

				Cm (L x P x H)	Inches (W x D x H)
Moduli contenitori Air Up S h 38.1 cm per Air Desk 1 Up.	Air Up S modules h 38.1 cm for Air Desk 1 Up.	Meubles Air Up S h 38.1 cm pour Air Desk 1 Up.	Air Up S-Möbel h 38.1 cm für Air Desk 1.	90 x 51 x 38.1 120 x 51 x 38.1	35½" x 20¼" x 15¼" 47¼" x 20¼" x 15¼"

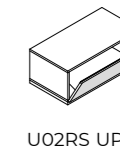
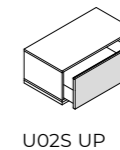
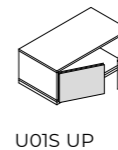
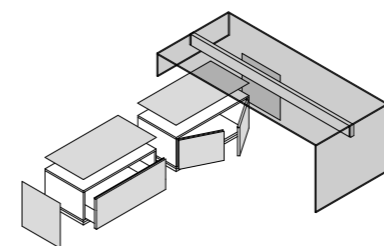

				Cm (L x P x H)	Inches (W x D x H)
Moduli contenitori Air Up h 48.1 cm per Air Desk 1 Up.	Air Up modules h 48.1 cm for Air Desk 1 Up.	Meubles Air Up h 48.1 cm pour Air Desk 1 Up.	Air Up-Möbel h 48.1 cm für Air Desk 1 Up.	90 x 51 x 48.1 120 x 51 x 48.1	35½" x 20¼" x 19" 47¼" x 20¼" x 19"

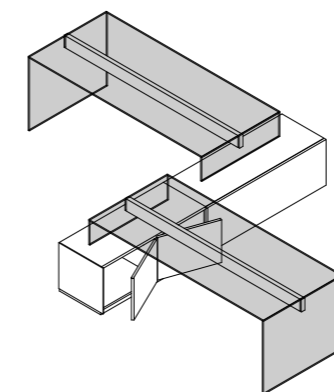
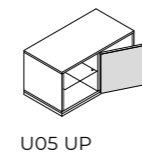
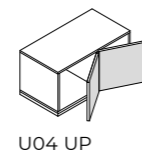
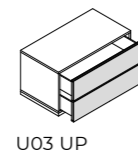
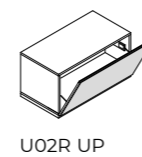
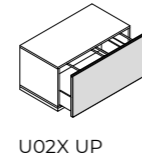
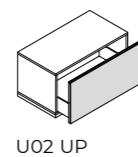
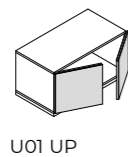
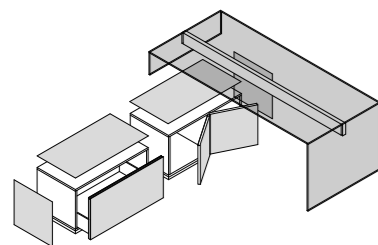

p. 75, 76-77

Composizione Air Up da 482x51x95,5h cm rivestita in cristallo retroverniciato cemento satinato. Scrivania in appoggio in cristallo trasparente extralight da 180x90x74h cm e parti metalliche in alluminio anodizzato. Sedia OFX 09 h85 cm in ecopelle bianca.

Air Up composition 482 x51x95,5h cm covered by satin cement painted glass. Extralight transparent glass desk with one side resting 180x90x74h cm and anodised aluminium metal parts. Chair OFX 09 h85 cm in white eco-leather.

Composition Air Up 482 x51x95,5h cm recouverte de verre verni ciment satiné. Bureau avec un côté posé, en verre transparent extralight de 180x90x74h cm et parties métalliques en aluminium anodisé. Chaise OFX 09 h85 cm en simili cuir blanc.

Komposition Air Up 482 x51x95,5h cm mit zement matt satiniertem Glas umkleidet. Schreibtisch aufgesetzt aus Glas klar Extralight von 180x90x74h cm und Metallteile eloxiertes Aluminium. Stuhl OFX 09 h85 cm Spaltleder weiss.

p. 74

Dettaglio passacavi.

Cable management detail.

Détail du passage de câbles.

Detail der Kabeldurchlass.





Air Desk Hall

Scrivania per reception in cristallo temperato 12mm retroverniciato nei colori del campionario nella versione brillante o satinata. Disponibile con pannello frontale e spalle in cristallo retroverniciato nei colori del campionario nella versione brillante o satinata (Opzioni A, B, C e D). Parti metalliche in acciaio inox lucido, satinato oppure alluminio anodizzato, laccato bianco o nero goffrato. Su richiesta alluminio spazzolato a mano nei colori nero o titanio. Per consentire il passaggio dei cavi è possibile richiedere una foratura nel piano. Distanza minima dal bordo: 10cm.

Reception desk in 12mm tempered painted glass top as per samples in the bright or satin version. Available also with front panel and sides in painted glass as per samples in the bright or satin version (Options A, B, C and D). Bright or satin stainless steel, anodised aluminium or embossed white or black lacquered metal parts. Hand brushed aluminium in the colours black or titanium grey, on request. For a proper cable management, a hole on the top can be arranged upon request. Minimum distance from the edge: 10cm.

Bureau pour la réception en verre trempé de 12mm d'épaisseur avec plateau en verre verni dans les coloris de nos échantillons dans la version brillante ou satinée. Disponible avec panneau frontal et côtés vernis dans les coloris de nos échantillons dans la version brillante ou satinée (Options A, B, C et D). Parties métalliques en acier inox brillant, satiné ou en aluminium anodisé, laqué blanc ou noir gaufré. Sur demande aluminium brossé à la main dans les coloris noir ou gris titane. Pour permettre le passage des câbles un trou peut être réalisé dans le plateau. Distance minimum du bord: 10cm.

Empfangsschreibtisch: Glasplatte vorgespannt 12mm nach Musterkarte lackiert. Lackierung jeweils hochglanz oder matt satiniert. Lieferbar mit Frontpanel und Seiten Glas nach Musterkarte lackiert. Lackierung jeweils hochglanz oder matt satiniert (Optionen A, B, C und D). Metallteile Edelstahl (Inox) poliert, gebürstet oder eloxiertes Aluminium oder weiss oder schwarz strukturlackiert. Lieferbar auch Aluminium handgebürstet in den Farben schwarz oder titangrau. Kabel können durch eine zu bestellende Bohrung in der Platte geführt werden. Mindestabstand von der Kante: 10cm.

p.79	Scrivania per reception in cristallo retroverniciato champagne da 200x90x74/100h cm e parti metalliche in acciaio inox lucido.	Reception desk with champagne painted glass 200x90x74/100h cm and bright stainless steel metal parts.	Bureau pour la réception en verre verni champagne de 200x90x74/100h cm et parties métalliques en acier inox brillant.	Empfangsschreibtisch mit champagne matt Glas 200x90x74/100h cm und Metallteile Edelstahl (Inox) poliert.
p. 78	Suggerimenti per la retroverniciatura	Proposals for painted glass parts	Suggestions pour le verre verni	Vorschläge für Glas lackiert

A

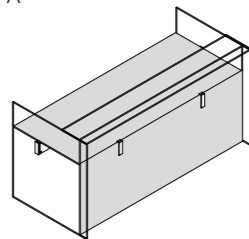

B

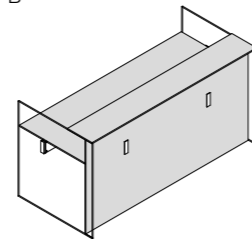

C

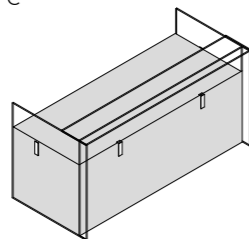

D

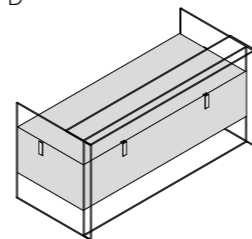



p.80 **Scrivania per reception con piano in cristallo retroverniciato bianco satinato da 200x90 x74/100h cm e parti metalliche in acciaio inox lucido. Sottomano Air Pad in alluminio verniciato bianco.** Reception desk with satin white painted glass top 200x90x74/100h cm and bright stainless steel metal parts. Air Pad writing pad in white lacquered aluminium. Bureau pour la réception avec plateau en verre blanc satiné de 200x90 x74/100h cm et parties métalliques en acier inox brillant. Air Pad sous-main en aluminium laqué blanc. Empfangsschreibtisch mit weiss matt satiniertes Glasplatte 200x90x74/100h cm und Metallteile Edelstahl (Inox) poliert. Air Pad Schreibunterlage Aluminium weiss.

p.81 **Suggerimenti per soluzioni personalizzate.** Suggestions for customised options. Suggestions pour solutions personnalisées. Vorschläge für die persönliche Ausführungen.

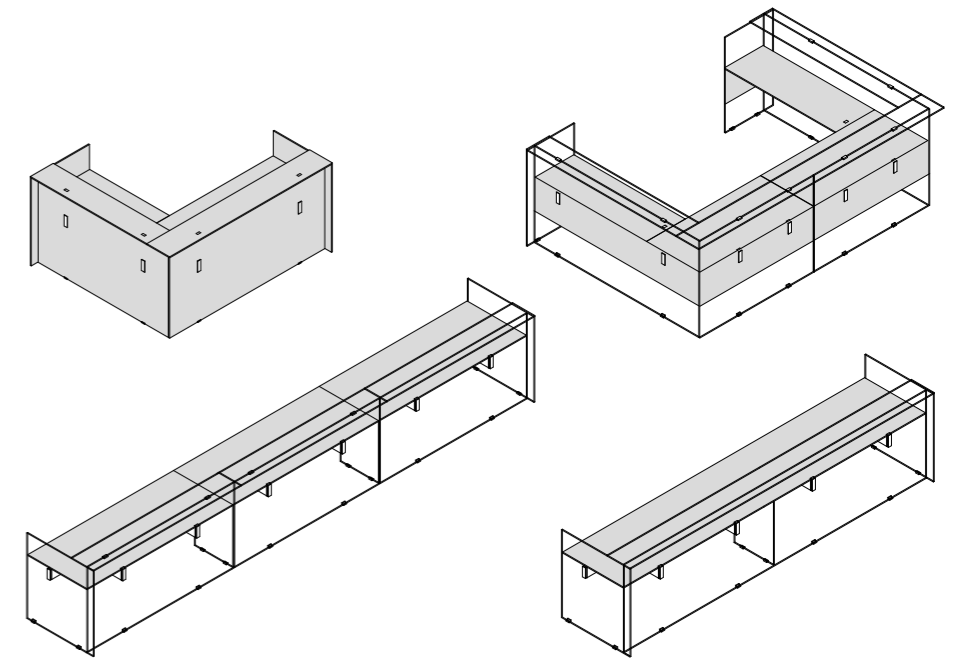

Air Desk Hall

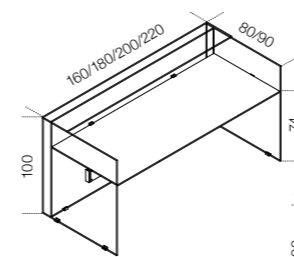

Air Desk Hall XL

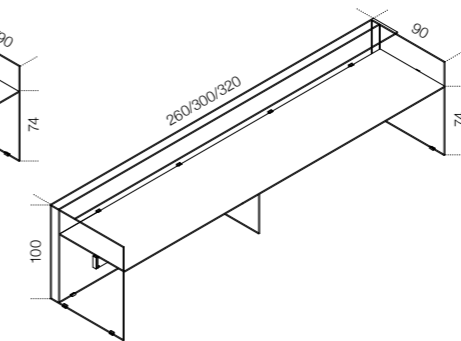

Air Desk Hall

Cm (L x P x H)
160 x 80 x 74/100
180 x 90 x 74/100
200 x 90 x 74/100
220 x 90 x 74/100
260 x 90 x 74/100
300 x 90 x 74/100
320 x 90 x 74/100

Air Desk Hall XL

Inches (W x D x H)
63" x 31½" x 29¼"/39½"
71" x 35½" x 29¼"/39½"
78¾" x 35½" x 29¼"/39½"
86¾" x 35½" x 29¼"/39½"
102½" x 35½" x 29¼"/39½"
118¾" x 35½" x 29¼"/39½"
126" x 35½" x 29¼"/39½"

Air Desk L

Scrivania con estensione del piano in cristallo trasparente, extralight o "grigio Italia" temperato 12mm. Disponibile con piano retroverniciato nei colori del campionario nella versione brillante o satinata oppure in cristallo laminato effetto pelle. Su richiesta spalle retroverniciate nei colori del campionario nella versione brillante o satinata. Parti metalliche in acciaio inox lucido, satinato oppure alluminio anodizzato o laccato bianco o nero goffrato. Su richiesta alluminio spazzolato a mano nei colori nero o titanio. Disponibile con estensione sul lato destro o sinistro. Per consentire il passaggio dei cavi è possibile richiedere una foratura nel piano oppure il passaggio, degli stessi, attraverso la trave e uscita dal tappo laterale (vedi pag. 36). Distanza minima dal bordo: 10cm.

Desk with return in 12mm transparent, extralight or smoked "grigio Italia" tempered glass top. Also available with painted glass top as per samples in the bright or satin version, or leather effect laminated glass top. Sides available in painted glass as per samples in the bright or satin version, on request. Bright or satin stainless steel, anodised aluminium or embossed white or black lacquered metal parts. Hand brushed aluminium in the colours black or titanium grey, on request. Return available on right or left side. For a proper cable management, a hole on the top can be arranged upon request, or cables can pass through the beam to be pulled out from one side (see page 36). Minimum distance from the edge: 10cm.

Bureau avec retour en verre transparent, extralight ou «grigio Italia» fumé trempé de 12mm d'épaisseur. Disponible aussi avec plateau en verre verni dans les coloris de nos échantillons dans la version brillante ou satinée, ou en verre revêtu effet cuir. Sur demande, côtés en verre verni dans les coloris de nos échantillons dans la version brillante ou satinée. Parties métalliques en acier inox brillant, satiné ou en aluminium anodisé, laqué blanc ou noir gaufré. Sur demande aluminium brossé à la main dans les coloris noir ou gris titane. Retour disponible à droit ou à gauche. Pour permettre le passage des câbles un trou peut être réalisé dans le plateau, ou les câbles peuvent passer dans la poutre et sortir par un côté (voir page 36). Distance minimum du bord: 10cm.

Schreibtisch Winkelkombination: vorgespanntes Glas klar, Extralight oder Rauchglas "grigio Italia" 12mm. Lieferbar mit Glasplatte nach Musterkarte lackiert. Lackierung jeweils hochglanz oder matt satiniert. Auf Wunsch Glasseiten mit Leder-Effekt umkleidet. Auf Wunsch Glasseiten nach Musterkarte lackiert. Lackierung jeweils hochglanz oder matt satiniert. Metallteile Edelstahl (Inox) poliert, gebürstet oder eloxiertes Aluminium oder weiss oder schwarz strukturlackiert. Lieferbar auch Aluminiumhandgebürstet in den Farben schwarz oder titangrau. Der kleine Schreibtisch lieferbar auf rechter oder linker Seite. Für die Kabelführung kann eine Bohrung in der Glasplatte oder durch den hohlen Balken unterhalb der Bohrung in der Glasplatte auf der Oberseite des Balkens unterhalb der Bohrung in der Glasplatte oder durch einen Auslass in der stirnseitigen Abdeckung des Balkens. (siehe Seite 36). Mindestabstand von der Kante: 10cm.

Cm (L x P x H)

180 x 206 x 74

200 x 206 x 74

Inches (W x D x H)

71" x 81¼" x 29¼"

78¾" x 81¼" x 29¼"

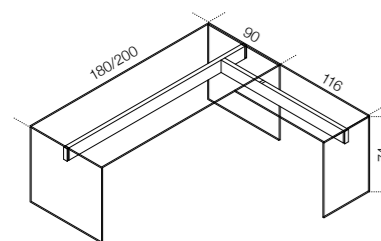

Air Desk Modesty

Scrivania per reception con piano temperato 12mm retroverniciato nei colori del campionario nella versione brillante o satinata. A richiesta piano in cristallo laminato effetto pelle e spalle in cristallo trasparente o "grigio Italia". Su richiesta spalle retroverniciate nei colori del campionario nella versione brillante o satinata. Pannello frontale laminato effetto pelle. Disponibile anche laccato bianco o nero gofrato o laccato effetto tessuto nei colori castagna, sabbia e canapa. Parti metalliche in acciaio inox lucido, satinato oppure alluminio anodizzato o laccato bianco o nero gofrato. Su richiesta alluminio spazzolato a mano anodizzato color nero. Per consentire il passaggio dei cavi è possibile richiedere una foratura nel piano oppure il passaggio, degli stessi, attraverso la trave e uscita dal tappo laterale (vedi pag. 36). Distanza minima dal bordo: 10cm.

Reception desk with 12mm tempered painted glass top as per samples in the bright or satin version. Leather effect laminated glass top and transparent or smoked "grigio Italia" glass sides, on request. Sides available in painted glass as per samples in the bright or satin version, on request. Frontal panel leather effect laminated. Also available embossed white or black lacquered or with "fabric" touch effect lacquered in the colours chestnut, sand and canapa. Bright or satin stainless steel, anodised aluminium or embossed white or black lacquered metal parts. Black hand brushed aluminium, on request. For a proper cable management, a hole on the top can be arranged upon request, or cables can pass through the beam and be pulled out from one side (see page 36). Minimum distance from the edge: 10cm.

Bureau pour la réception avec plateau en verre trempé de 12mm d'épaisseur verni dans les coloris de nos échantillons dans la version brillante ou satinée. Sur demande plateau en verre revêtu effet cuir et côtés en verre transparent ou "grigio Italia" fumé. Sur demande, côtés en verre verni dans les coloris de nos échantillons dans la version brillante ou satinée. Panneau frontal revêtu effet cuir. Disponible aussi laqué blanc ou noir gaufré ou laqué avec effet tissu dans les coloris châtaigne, sablé et chanvre. Parties métalliques en acier inox brillant, satiné ou en aluminium anodisé, laqué blanc ou noir gaufré. Sur demande aluminium brossé à la main noir. Pour permettre le passage des câbles un trou peut être réalisé dans le plateau, ou les câbles peuvent passer dans la poutre et sortir par un côté (voir page 36). Distance minimum du bord: 10cm. Empfangsschreibtisch: Glasplatte vorgespannt 12mm nach Musterkarte lackiert. Lackierung jeweils hoch-

glanz oder matt satiniert. Auf Wunsch Glasplatte mit Leder-Effekt umkleidet und Seitenwangen Glas klar oder Rauchglas "grigio Italia". Auf Wunsch Glasseiten nach Musterkarte lackiert. Lackierung jeweils hochglanz oder matt satiniert. Frontpaneel mit Leder-Effekt umkleidet. Lieferbar auch weiss oder schwarz strukturlackiert oder lackiert mit Stoff-Effekt in kastanienbraun, sandfarben und hanffarben. Metallteile Edelstahl (Inox) poliert, gebürstet oder eloxiertes Aluminium oder weiss oder schwarz strukturlackiert. Lieferbar auch Aluminium handgebürstet schwarz eloxiert. Für die Kabelführung kann eine Bohrung in der Glasplatte vorgesehen werden. Die Kabel können zudem durch den hohlen Balken geföhrt werden, entweder durch eine Bohrung auf der Oberseite des Balkens unterhalb der Bohrung in der Glasplatte oder durch einen Auslass in der stirnseitigen Abdeckung des Balkens. (siehe Seite 36). Mindestabstand von der Kante: 10cm.

pp. 85, 86-87

Scrivania per reception da 300x90x74h/105h cm con piano in cristallo "grigio Italia" laminato effetto pelle e spalle in cristallo "grigio Italia". Pannello frontale laminato effetto pelle. Parti metalliche alluminio spazzolato nero. Sedia OFX 09 h85 cm in pelle scamosciata Sand 012. Lampada Bolle.

Reception desk 300x90x74h/105h cm with smoked "grigio Italia" leather effect laminated glass top and smoked "grigio Italia" glass sides. Leather effect laminated front panel. Black hand brushed aluminium metal parts. Chair OFX 09 h85 cm in suede Sand 012. Bolle lamp.

Bureau pour la réception de 300x90x74h/105h cm avec plateau en verre "grigio Italia" fumé revêtu effet cuir et côtés en verre "grigio Italia" fumé. Panneau frontal revêtu effet cuir. Parties métalliques en aluminium brossé noir. Chaise OFX 09 h85 cm en suédine Sand 012. Lampe Bolle.

Empfangsschreibtisch 300x90x74h/105h cm: Glasplatte Rauchglas "grigio Italia" mit Leder-Effekt umkleidet und Seiten Rauchglas "grigio Italia". Frontpaneel mit Leder-Effekt umkleidet. Metallteile Aluminium schwarz handgebürstet. Stuhl OFX 09 h85 cm Wildleder Sand 012. Lampe Bolle.





- p. 89 Scrivania per reception da 300x90x74h/105h cm con piano in cristallo "grigio Italia" laminato effetto pelle e spalle in cristallo "grigio Italia". Pannello frontale laminato effetto pelle. Parti metalliche alluminio spazzolato nero. Cassettiera Air Drawer in cristallo retroverniciato visone satinato. Sedia OFX 09 h85 cm in pelle scamosciata Sand 012.
- Reception desk 300x90 x74h/105h cm with smoked "grigio Italia" leather effect laminated glass top and smoked "grigio Italia" glass sides. Leather effect laminated front panel. Black hand brushed aluminium metal parts. Air Drawer covered by satin mink painted glass. Chair OFX 09 h85 cm in suede Sand 012.
- Bureau pour la réception de 300x90x74h/105h cm avec plateau en verre "grigio Italia" fumé revêtu effet cuir et côtés en verre "grigio Italia" fumé. Panneau frontal revêtu effet cuir. Parties métalliques en aluminium brossé noir. Air Drawer bloc tiroir recouvert de verre verni vison satiné. Chaise OFX 09 h85 cm en suédine Sand 012.
- Empfangsschreibtisch 300x90x74h/105h cm: Glasplatte Rauchglas "grigio Italia" mit Leder-Effekt umkleidet und Seiten Rauchglas "grigio Italia". Frontpaneel mit Leder-Effekt umkleidet. Metallteile Aluminium schwarz handgebürstet. Air Drawer Rollcontainer mit Nerzfarbe matt satinier-tem Glas umkleidet. Stuhl OFX 09 h85 cm Wildleder Sand 012.

- p. 88 La versione XL da 260x110 cm prevede una spalla intermedia.
- The XL version, from 260x110 cm, includes one middle glass side.
- La version XL, à partir de 260x110 cm, est réalisée avec une côté intermédiaire.
- Die XL-Ausführung ab 260x110 cm wird mit einer Zwischenseitenwange geliefert.

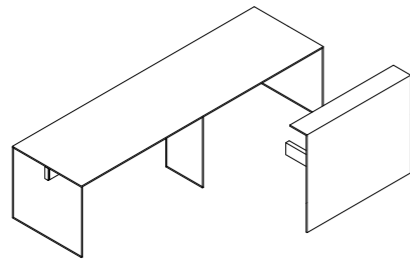

- p. 88 La distanza tra il piano e il pannello frontale è di 12 mm e permette il passaggio dei cavi.
- The distance between the top and the front panel of the desk is 12 mm and allows the cable connection.
- La distance entre le plateau et le panneau frontal est de 12 mms et permet les passage des câbles.
- Der Abstand zwischen der Glasplatte und dem Frontpaneel ist 12 mm und ist für den Kabeldurchlass geeignet.

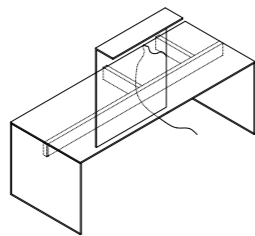
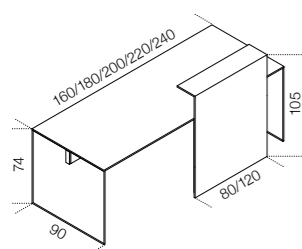
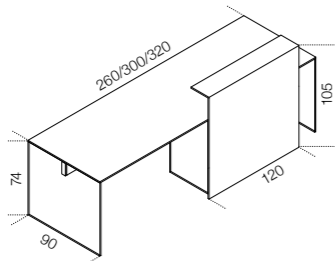
**Air Desk Modesty****Air Desk Modesty XL****Air Desk Modesty**

Cm (L x P x H)

160 x 80 x 74/105
180 x 90 x 74/105
200 x 90 x 74/105
220 x 90 x 74/105
240 x 90 x 74/105

Air Desk Modesty XL

260 x 90 x 74/105
300 x 90 x 74/105
320 x 90 x 74/105

Inches (W x D x H)

63" x 31½" x 29¼"/41½"
71" x 35½" x 29¼"/41½"
78¾" x 35½" x 29¼"/41½"
86¾" x 35½" x 29¼"/41½"
94½" x 35½" x 29¼"/41½"
102½" x 35½" x 29¼"/41½"
118¼" x 35½" x 29¼"/41½"
126" x 35½" x 29¼"/41½"



Air Desk W

Scrivania in cristallo trasparente, extralight o "grigio Italia" temperato 12mm. Disponibile con piano retroverniciato nei colori del campionario nella versione brillante o satinata. Su richiesta spalle retroverniciate nei colori del campionario nella versione brillante o satinata. Parti metalliche in acciaio inox lucido, satinato oppure alluminio anodizzato o laccato bianco o nero goffrato. Su richiesta alluminio spazzolato a mano anodizzato nei colori nero o titanio. Cassetto in frassino naturale, tinto tabacco o tinto nero poro aperto. Vano predisposto per cablaggio. Disponibile con cassetto a destra o sinistra.

Desk with 12mm transparent, extralight or smoked "grigio Italia" tempered glass. Also available with painted glass top as per samples in the bright or satin version. Sides available in painted glass as per samples in the bright or satin version, on request. Bright or satin stainless steel, anodized aluminium or embossed white or black lacquered metal parts. Hand brushed aluminium in the colours black or titanium grey, on request. Drawer in natural ash, tobacco stained or black lacquered open pore wood. Equipped unit for cable management. Drawer available on the right or left side.

Bureau en verre transparent, extralight ou "grigio Italia" fumé trempé de 12mm d'épaisseur. Disponible avec plateau en verre verni dans les coloris de nos échantillons dans la version brillante ou satinée. Sur demande, côtés en verre verni dans les coloris de nos échantillons dans la version brillante ou satinée. Parties métalliques en acier inox brillant, satiné ou en aluminium anodisé ou laqué blanc ou noir gaufré. Sur demande aluminium brossé à la main dans les coloris noir ou gris titane. Tiroir en frêne naturel, teinté tabac ou noir pores ouverts. Pièce préparée pour le passage des câbles. Tiroir disponible à droite ou à gauche.

Schreibtisch: Glas vorgespant klar, Extralight oder Rauchglas "grigio Italia" 12mm. Glasplatte lieferbar auch nach Musterkarte lackiert. Lackierung jeweils hochglanz oder matt satiniert. Auf Wunsch Glasseiten nach Musterkarte lackiert. Lackierung jeweils hochglanz oder matt satiniert. Metallteile Edelstahl (Inox) poliert, gebürstet oder eloxiertes Aluminium oder weiss oder schwarz strukturlackiert. Lieferbar auch Aluminium handgebürstet in den Farben schwarz oder tiffanygrau. Holzschublade Eschenholz natur, Tabakfarbe gebeizt oder schwarz offenporig lackiert. Ein Fach für die Verkabelung verwendet. Schublade lieferbar rechts oder links.

p. 91 Scrivania in cristallo "grigio Italia" da 160x65x74h cm. Parti metalliche in alluminio spazzolato a mano nero. Cassetto in frassino tinto tabacco.

Smoked "grigio Italia" glass desk 160x65x74h cm. Black hand brushed aluminium metal parts. Drawer in tobacco stained ash.

Bureau en verre "grigio Italia" fumé de 160x65x74h cm. Parties métalliques en aluminium brossé noir. Tiroir en frêne teinté tabac.

Schreibtisch: Rauchglas "grigio Italia" 160x65x74h cm. Metallteile Aluminium schwarz handgebürstet. Holzschublade Tabakfarbe gebeizt.

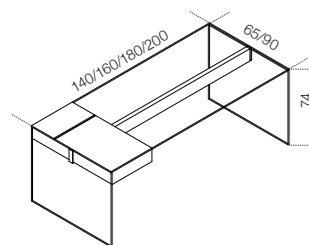

Cm (L x P x H)

140 x 65 x 74
160 x 65 x 74
180 x 65 x 74
200 x 90 x 74

Inches (W x D x H)

55¼" x 25¾" x 29¼"
63" x 25¾" x 29¼"
71" x 25¾" x 29¼"
78¾" x 35½" x 29¼"



Milano

Milano

Scrivania direzionale con struttura e cassetti in frassino naturale, tinto tabacco o tinto nero poro aperto. Piano in cristallo trasparente o extralight 15mm. Disponibile anche piano in cristallo "grigio Italia" 12mm temperato. Sottomano in pelle scamosciata o cuoio, nei colori del campionario.

Executive desk with structure and drawers in natural ash, tobacco stained or black lacquered open pore wood. 15mm transparent or extralight glass top. Also available with 12mm smoked "grigio Italia" tempered glass top. Suede or leather writing pad as per samples.

Bureau de direction avec structure et tiroirs en frêne naturel, teinté tabac ou laqué noir pore ouvert. Plateau en verre transparent ou extralight de 15mm d'épaisseur. Disponible aussi plateau en verre "grigio Italia" fumé trempé de 12mm d'épaisseur. Sous-main en suédine ou cuir dans les coloris de nos échantillons.

Executivschreibtisch: Gestell und Schubladen Eschenholz, Tabakfarbe gebeizt oder schwarz offenporig lackiert. Glasplatte 15mm klar oder Extralight. Auch vorgespannt Glas Rauchglas "grigio Italia" 12mm lieferbar. Schreibunterlage Wildleder oder Leder in den Farben nach Musterkarte.

Milano 1

Scrivania direzionale con struttura e cassetti in frassino naturale, tinto tabacco o tinto nero poro aperto in appoggio su Milano contenitore con ante e cassetti (fronte) e vani a giorno (retro). Contenitore disponibile su lato destro o sinistro.

Executive desk with structure and drawers in natural ash, tobacco stained or black lacquered open pore wood. One side resting on Milano unit with doors and drawers (front) and open (back). Unit available on the right or left side.

Bureau de direction avec structure et tiroirs en frêne naturel, teinté tabac ou laqué noir pore ouvert posé sur meuble Milano avec portes et tiroirs (devant) et ouvert (arrière). Meuble disponible à droite ou à gauche.

Executivschreibtisch mit Holzgestell und Schubladen aus Eschenholz, Tabakfarbe gebeizt oder schwarz offenporig lackiert aufgesetzt auf Milano Element mit Türen und Schubladen (Front) und offen (Rückseite). Element lieferbar rechts oder links.

p. 93 Scrivania in appoggio su contenitore in frassino tinto tabacco e piano in cristallo trasparente extralight da 286x180 cm. Sedia OFX 09 h115 cm in pelle scamosciata Sand 006. Sottomano in pelle scamosciata Sand 006.

Desk with one side resting on tobacco stained ash unit and extralight transparent glass top 286x180 cm. Chair OFX 09 h115 cm in suede Sand 006. Suede Sand 006 leather writing pad.

Bureau avec un côté posé sur le meuble en frêne teinté tabac et plateau en verre transparent extralight 286x180 cm. Chaise OFX 09 h115 cm en suédine Sand 006. Sous-main en suédine Sand 006.

Schreibtisch aufgesetzt auf Möbel aus Eschenholz Tabakfarbe gebeizt und Glasplatte klar Extralight 286x180 cm. Stuhl OFX 09 h115 cm Wildleder Sand 006. Schreibunterlage aus Wildleder Sand 006.





Milano

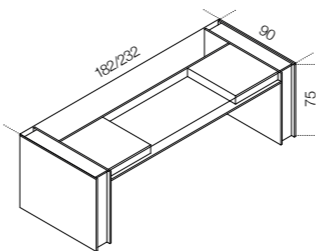

Milano 1

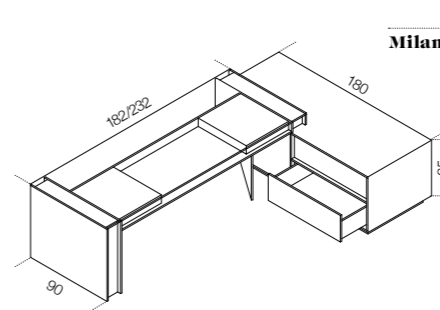

Milano

Cm (L x P x H)
182 x 90 x 75
232 x 90 x 75
236 x 180 x 75
286 x 180 x 75

Milano 1

Inches (W x D x H)
71 ³ / ₄ " x 35 ¹ / ₂ " x 29 ³ / ₄ "
91 ¹ / ₂ " x 35 ¹ / ₂ " x 29 ³ / ₄ "
93" x 71" x 29 ³ / ₄ "
112 ³ / ₄ " x 71" x 29 ³ / ₄ "

President Scrivania/ President Dattilo

Scrivania e Dattilo in cristallo trasparente oppure extralight temperato. Parti metalliche in acciaio inox lucido. A richiesta acciaio inox satinato, ottone lucido, satinato o laccato bianco o nero goffrato. Per consentire il passaggio dei cavi è possibile richiedere una foratura nel piano, foro diam 6cm, mantenendo una distanza minima dal bordo di 10cm.

Desk and return in transparent or extralight tempered glass. Bright stainless steel metal parts. Satin stainless steel, bright or satin brass or embossed white or black lacquered metal parts, on request. For a proper cable management, a diam. 6cm hole on the top can be arranged upon request. Minimum distance from the edge: 10cm.

Bureau et retour en verre trempé transparent ou extralight. Parties métalliques en acier inox brillant. Sur demande acier inox satiné, laiton brillant, satiné ou laqué blanc ou noir gaufré. Pour permettre le passage des câbles un trou de 6 cm de diamètre peut être réalisé dans le plateau. Distance minimum du bord: 10 cm.

Schreibtisch: vorgespanntes Glas klar oder Extralight. Metallteile Edelstahl (Inox) poliert. Auf Wunsch Edelstahl (Inox) gebürstet, Messing hochglanz, satiniert oder weiss oder schwarz strukturlackiert. Kabel können durch eine zu bestellende Bohrung (Durch. Cm 6) in der Platte geführt werden. Mindestabstand von der Kante: 10cm.

- p. 97 Dattilo in cristallo trasparente extralight e parti metalliche in acciaio inox lucido. Extralight transparent glass return and bright stainless steel metal parts. Retour en verre transparent extralight et parties métalliques en acier inox brillant. Schreibtisch Glas klar Extralight und Metallteile aus Edelstahl (Inox) poliert.
- pp. 98-99 Scrivania in cristallo trasparente extralight da 180x85x74h cm e parti metalliche in acciaio inox lucido. Dattilo in cristallo trasparente extralight e parti metalliche in acciaio inox lucido. Sedie OFX 09 85h cm in pelle scamosciata Grey 074. Composizione Air Up da 121,5x51x143h cm rivestita in cristallo retroverniciato cemento satinato. Extralight transparent glass desk 180x85x74h cm and bright stainless steel metal parts. Extralight transparent glass return and bright stainless steel metal parts. Chairs OFX 09 85h cm in suede Grey 074. Air Up composition 121,5x51x143h cm covered by satin cement painted glass. Bureau en verre transparent extralight de 180x85x74h cm et parties métalliques en acier inox brillant. Retour en verre transparent extralight et parties métalliques en acier inox brillant. Chaises OFX 09 85h cm en suédine Grey 074. Composition Air Up 121,5x51x143h cm recouverte de verre verni ciment satiné. Schreibtisch Glas klar Extralight 180x85x74h cm und Metallteile aus Edelstahl (Inox) poliert. Schreibtisch Glas Extralight und Metallteile aus Edelstahl (Inox) poliert. Stühle OFX 09 Wildleder Grey 074. Komposition Air Up 121,5x51x143h cm mit zement matt satiniertem Glas umkleidet.

President Scrivania

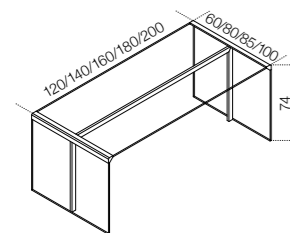

President Dattilo

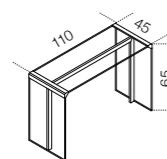

Glass	mm	Inches	Cm (L x P x H)	Inches (W x D x H)
10	4"		110 x 45 x 65	43½" x 17¾" x 25¾"
10	4"		120 x 60 x 74	47¼" x 23¾" x 29¼"
10	4"		140 x 60 x 74	55¼" x 23¾" x 29¼"
10	4"		160 x 80 x 74	63" x 31½" x 29¼"
12	4¾"		180 x 85 x 74	71" x 33½" x 29¼"
12	4¾"		200 x 100 x 74	78¾" x 39½" x 29¼"





President Junior/ President Senior

Scrivania in cristallo trasparente, extralight o "grigio Italia" temperato 12mm. Parti metalliche in acciaio inox lucido o satinato. Disponibili anche in ottone lucido, ottone satinato o laccato bianco o nero gofrato. Per consentire il passaggio dei cavi è possibile richiedere una foratura nel piano, foro diam 6cm, mantenendo una distanza minima dal bordo di 10cm.

Desk with 12mm transparent, extralight or smoked "grigio Italia" tempered glass. Bright or satin stainless steel metal parts. Also available bright brass, satin brass or embossed white or black lacquered metal parts. For a proper cable management, a diam. 6cm hole on the top can be arranged upon request. Minimum distance from the edge: 10cm.

Bureau en verre transparent, extralight ou "grigio Italia" fumé trempé de 12mm d'épaisseur. Parties métalliques en acier inox brillant ou acier inox satiné. Disponible aussi en laiton brillant, laiton satiné ou laqué blanc ou noir gaufré. Pour permettre le passage des câbles un trou de 6cm de diamètre peut être réalisé dans le plateau. Distance minimum du bord: 10cm.

Schreibtisch: Glas vorgespannt klar, Extralight oder Rauchglas "grigio Italia" 12mm. Metallteile Edelstahl (Inox) poliert oder gebürstet. Lieferbar auch Messing hochglanz, satiniert oder weiss oder schwarz strukturlackiert. Kabel können durch eine zu bestellende Bohrung (Durch. Cm 6) in der Platte geführt werden. Mindestabstand von der Kante: 10cm.

p. 101 Scrivania in cristallo "grigio Italia" e parti metalliche in ottone satinato. Sedia 0414 in rose powder 4512 e pouf Lou L in velvet blue 408.

"Grigio Italia" glass desk and satin brass metal parts. Chair 0414 in velvet rose powder 4512 and pouf Lou L in velvet blue 408.

Bureau en verre "grigio Italia" fumé et parties métalliques en laiton satiné. Chaise 0414 en velours rose powder 4512 et pouffe Lou L en velours blue 408.

Schreibtisch Rauchglas "Grigio Italia" und Metallteile aus Messing satiniert. Stuhl 0414 samt rose powder 4512 und pouffe Lou L en Samt blue 408.

President Senior

President Junior

Senior

Junior

Cm (L x P x H)

210 x 106 x 74

172 x 80 x 74

Inches (W x D x H)

82¾" x 41¾" x 29¼"

67¾" x 31½" x 29¼"

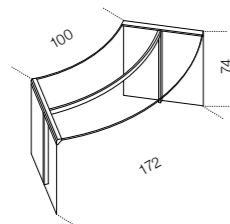
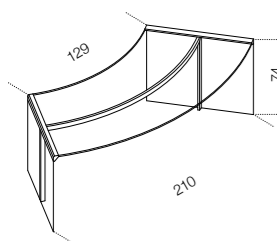

WGS

Scrivania con piano in cristallo trasparente, extralight o "grigio Italia" temperato 12mm. A richiesta retroverniciato nei colori del campionario nella versione brillante o satinata. Base in rovere spazzolato naturale, tinto wengé, laccato bianco o nero a poro aperto. Parti metalliche in acciaio inox lucido. Disponibile fino ad esaurimento scorte.

Desk with 12mm transparent, extralight or smoked "grigio Italia" tempered glass top. Painted glass as per sample in the bright or satin version, on request. Brushed natural oak, wengé stained, white or black open pore lacquered base. Bright stainless steel metal parts. Available while stocks last.

Bureau avec plateau en verre transparent, extralight ou "grigio Italia" fumé trempé de 12mm d'épaisseur. Sur demande aussi en verre verni dans les coloris de nos échantillons dans la version brillante ou satinée. Piètement en chêne naturel brossé, teinté wengé, laqué blanc ou noir pore ouvert. Parties métalliques en acier inox brillant. Disponible jusqu'à épuisement de stock.

Schreibtisch: Glasplatte vorgespannt klar, Extralight oder Rauchglas "grigio Italia" 12mm. Glas lieferbar auch nach Musterkarte lackiert. Lackierung jeweils hochglanz oder matt satiniert. Gestell Eiche natur gebürstet, Wengé gebeizt, weiss oder schwarz lackiert offenporig. Metallteile Edelstahl (Inox) poliert. Lieferbar nur solange der Vorrat reicht.

pp. 104-105

Scrivania in cristallo trasparente extralight da 160x65x73h cm e base in rovere tinto wengé. Boiserie Elle Plus 10 in cristallo retroverniciato grigio umbro satinato. Sedia OFX 09 h85 cm in pelle scamosciata Grey 074.

Extralight transparent glass desk 160x65x73h cm and wengé stained oak base. Elle Plus 10 boiserie covered by satin dark grey painted glass. Chair OFX 09 h85 cm in suede Grey 074.

Bureau en verre transparent extralight de 160x65x73h cm et piètement en chêne teinté wengé. Elle Plus 10 boiserie recouvert de verre verni gris foncé satiné. Chaise OFX 09 h85 cm en suédine Grey 074.

Schreibtisch Glas klar Extralight 160x65x73h und Gestell Eiche Wengé gebeizt. Elle Plus 10 Boiserie mit dunkel grau matt satiniertem Glas umkleidet. Stuhl OFX 09 h85 cm Wildleder Grey 074.

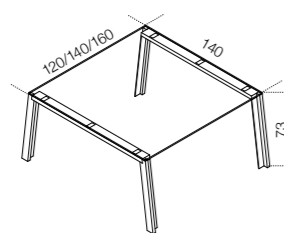
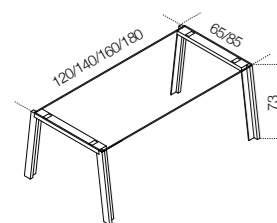

Cm (L x P x H)

120 x 65 x 73
140 x 65 x 73
160 x 65 x 73
140 x 85 x 73
160 x 85 x 73
180 x 85 x 73
120 x 140 x 73
140 x 140 x 73
160 x 140 x 73

Inches (W x D x H)

47¼" x 25¾" x 28¾"
55¼" x 25¾" x 28¾"
63" x 25¾" x 28¾"
55¼" x 33½" x 28¾"
63" x 33½" x 28¾"
71" x 33½" x 28¾"
47¼" x 55¼" x 28¾"
55¼" x 55¼" x 28¾"
63" x 55¼" x 28¾"





WGS Double

Sistema modulare di scrivanie con piano in cristallo trasparente, extralight o "grigio Italia" temperato 12mm. A richiesta retroverniciato nei colori del campionario, nella versione brillante o satinata. Base in rovere spazzolato naturale, tinto wengé, la cato bianco o nero poro aperto. Parti metalliche in acciaio inox lucido. Il "cavalletto doppio", che consente il collegamento tra più moduli, è predisposto per il passaggio dei cavi e dotato di una fascia di chiusura in feltro "natural". Si presta per l'inserimento degli accessori (WGS Glove e WGS Screen). Disponibile fino ad esaurimento scorte.

Modular system of desks with 12mm transparent, extralight or smoked "grigio Italia" tempered glass top. Painted glass as per samples in the bright or satin version, on request. Brushed natural oak, wengé stained, white or black open pore lacquered base. Bright stainless steel metal parts. The "double leg" is suitable for cable runway and supplied with cover band made in "natural" felt. It is required for the modules connection and a lows insertion of accessories (WGS Glove and WGS Screen). Available while stocks last.

Composition modulables de bureaux en verre transparent, extralight ou «grigio Italia» fumé trempé de 12mm d'épaisseur. Sur demande aussi en verre verni dans les coloris de nos échantillons dans la version brillante ou satinée. Piètement en chêne naturel brossé, teinté wengé, laqué blanc ou noir pore ouvert. Parties métalliques en acier inox brillant. Le «double chevalet», qui permet de joindre plusieurs modules, est préparé pour le passage des câbles et équipé avec une bande de couverture en feutre «natural». Il permet d'insérer les accessoires suivantes (WGS Glove ou WGS Screen). Disponible jusqu'à épuisement de stock.

Schreibtischezusammensetzung in modularer Weise: Glasplatte vorge-spannt klar, Extralight oder Rauchglas "grigio Italia" 12mm. Glas lieferbar auch nach Musterkarte lackiert. Lackierung jeweils hochglanz oder matt satiniert. Gestell Eiche natur gebürstet, Wengé gebeizt, weiss oder schwarz lackiert offenporig. Metallteile Edelstahl (Inox) poliert. Mit dem "Doppelreitern", zum Kabeldurchlass und mit einem Bezugstreifen in Filz "natural" verwendet, kann mehrere Module verbindet werden und kann die folgende Ergänzungsstücke zugesetzt werden (WGS Glove und WGS Screen). Lieferbar nur solange der Vorrat reicht.

pp. 107, 108-109

Composizione di scrivanie con piano in cristallo trasparente extralight da 460x140x73h cm (due da 160x140 e uno da 140x140 cm) e base in rovere spazzolato naturale. WGS Screen in feltro natural. Sedie OFX 09 h85 cm in ecopelle bianca. Composizioni Air Up Shelf in cristallo retroverniciato cemento brillante.

Composition of desks with extralight transparent glass top 460x140x73h cm (two of 160x140 cm and one 140x140 cm) and brushed natural oak base. WGS Screen in natural felt. Chairs OFX 09 h85 cm in white eco-leather. Air Up Shelf compositions in bright cement painted glass.

Composition de bureaux avec plateau en verre transparent extralight de 460x140x73h cm (deux de 160x140 cm et un 140x140cm) et piètement en chêne naturel brossé. WGS Screen en feutre naturel. Chaises OFX 09 h85 cm en simili cuir blanc. Compositions Air Up Shelf recouvertes de verre verni ciment brillant.

Schreibtischezusammensetzung: Glasplatte klar extralight 460x140x73h cm (zwei 160x140 cm und einer 140x140cm). Gestell Eiche natur gebürstet. WGS Screen in Filz natural. Stühle OFX 09 h85 cm Spaltleder weiss. Kompositionen Air Up Shelf mit Zement hochglänzendem Glas umkleidet.

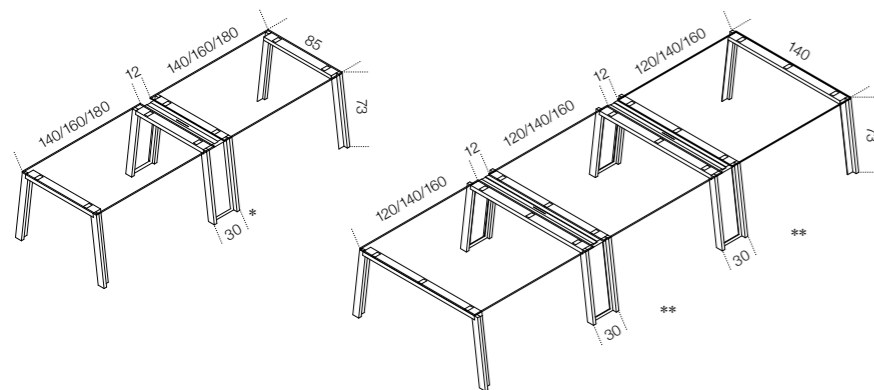

Cm (L x P x H)

30 x 85 x 73
30 x 140 x 73
140 x 85 x 73
160 x 85 x 73
180 x 85 x 73
120 x 140 x 73
140 x 140 x 73
160 x 140 x 73

Inches (W x D x H)

12" x 33½" x 28¾"
12" x 55¾" x 28¾"
55¼" x 33½" x 28¾"
63" x 33½" x 28¾"
71" x 33½" x 28¾"
47¼" x 55¼" x 28¾"
55¼" x 55¼" x 28¾"
63" x 55¼" x 28¾"





Zen

Scrivania con piano in palissandro e frassino. Base in alluminio spazzolato a mano e anodizzato nero con dettagli ottonati lucidi.

Desk with ash and rosewood top. Black and hand brushed anodised aluminium base with bright brass details.

Bureau avec plateau en frêne et palissandre. Piètement en aluminium brossé à la main et anodisé noir avec détails en laiton brillant.

Schreibtisch: Platte Eschenholz und Rosenholz. Gestell Aluminium handgebürstet schwarz eloxiert mit Details Messing poliert.

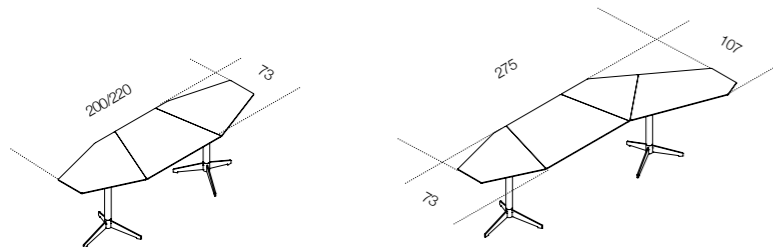

Cm (L x P x H)

200 x 73 x 74,5

220 x 73 x 74,5

275 x 73/107 x 74,5

Inches (W x D x H)

78¾" x 28¾" x 29½"

86¾" x 28¾" x 29½"

108½" x 28¾"/42¼" x 29½"

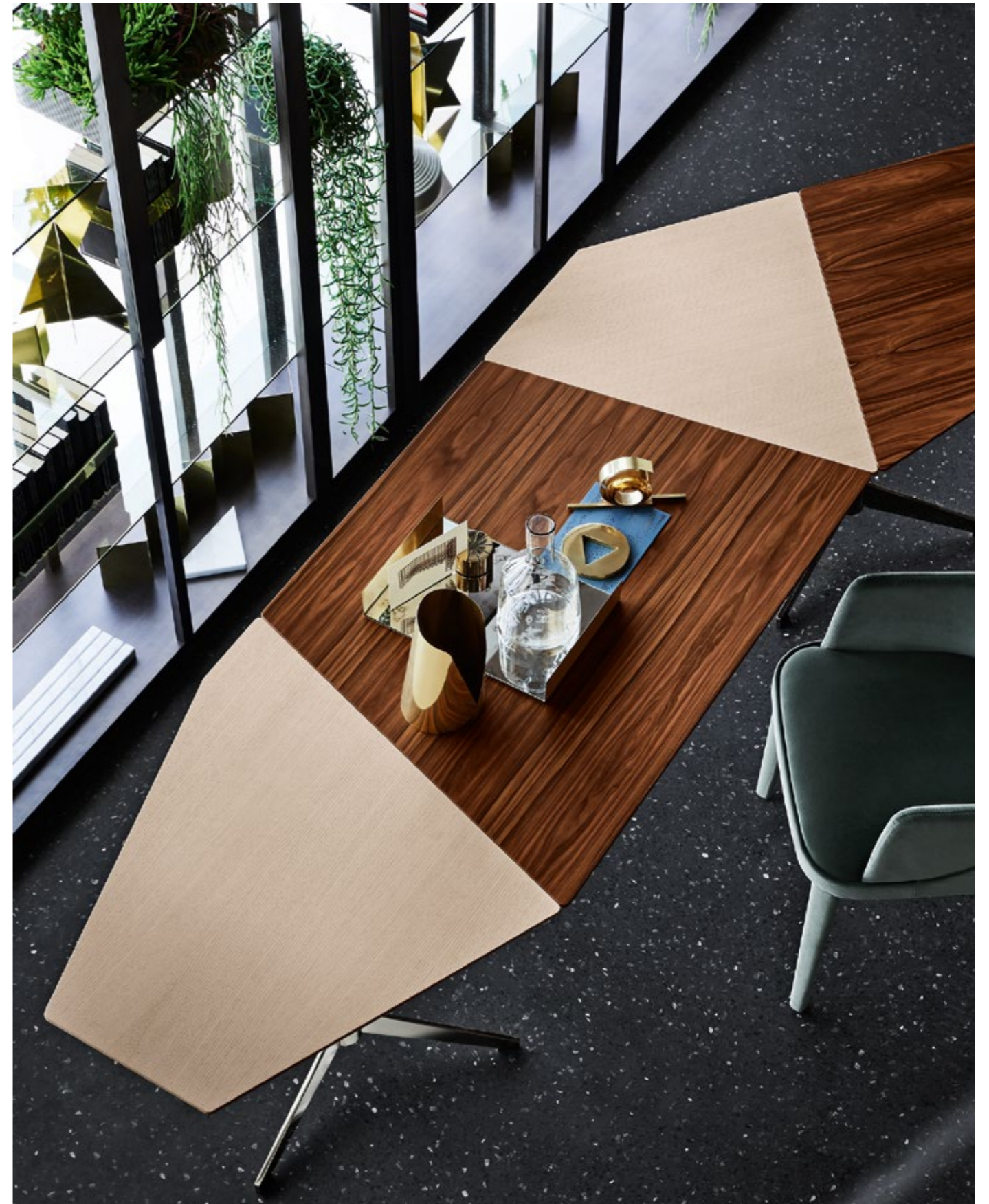

Cassettiere/ Drawer units/ Bloc tiroirs/ Rollcontainer

114 Air Drawer / Air Drawer 3
116 Movie Cassettiera
118 President Cassettiera
120 Techna 13

Air Drawer

Air Drawer

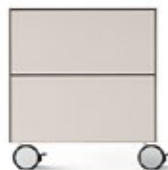

Cassetiera in legno montata su ruote, rivestita in cristallo 6mm temperato retroverniciato nei colori del campionario nella versione brillante e satinata. Cassetti ad estrazione totale con fondo in cristallo extralight 4mm temperato. Disponibile con serratura solo sul primo cassetto. Il cassetto può essere dotato di un vassoio portacancelleria in alluminio.

Air Drawer: Drawer unit on castors in wood with sides covered by 6mm tempered painted glass as per samples in the bright or satin version. On castors. Pull-out drawers; 4 mm tempered extralight glass bottom. Available with lock on the first drawer only. The drawer can be supplied with one aluminium stationery tray.

Air Drawer: Bloc tiroir en bois sur roulettes avec côtés recouvertes en verre de 6mm d'épaisseur trempé verni dans les coloris de nos échantillons dans la version brillante ou satinée. Tiroirs complètement extractibles; fond en verre extralight trempé de 4mm d'épaisseur. Disponible avec serrure uniquement sur le premier tiroir. Le tiroir peut avoir un plateau porteplumes en aluminium.

Air Drawer: Rollcontainer aus Holz mit vorgespanttem lackiertem Glaseiten 6mm. Lackierung nach Musterkarte jeweils hochglanz oder matt satiniert. Schubladen mit Vollauszug und Boden aus vorgespanttem Extralight Glas 4mm. Auf Wunsch mit Schloss auf der oberen Schublade. Der Schublade kann auf Wunsch mit einer Utensilientablett aus Aluminium geliefert werden.

Air Drawer 3

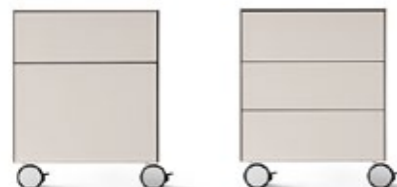

Cassetiera in legno montata su ruote, rivestita in cristallo 6mm temperato retroverniciato nei colori del campionario nella versione brillante e satinata. Cassetti ad estrazione totale con apertura push-pull. Disponibile la versione con cassetto per cartelle sospese. (Per Usa disponibile solo versione "letter size"). Il cassetto può essere dotato di un vassoio portacancelleria in alluminio. A richiesta versione senza ruote (altezza finita 57,5cm).

Drawer unit on castors in wood with sides covered by 6mm tempered painted glass as per samples in the bright or satin version. Pull-out and push-pull drawers. Available with drawer for hanging files. (For Usa only "letter size" version available). The drawer can be supplied with one aluminium stationery tray. Version without castors on request (total height 57,5 cm).

Bloc tiroir en bois sur roulettes avec côtés recouvertes en verre de 6mm d'épaisseur trempé verni dans les coloris de nos échantillons dans la version brillante. Bloc tiroir avec tiroirs complètement extractibles avec ouverture push pull. Sur demande version avec tiroir pour dossiers suspendus. (Pour les Etats-Unis disponible seulement version «letter size»). Sur demande version sans roulettes (hauteur totale 57,5 cm).

Rollcontainer aus Holz mit vorgespanttem lackiertem Glaseiten 6mm. Lackierung nach Musterkarte jeweils hochglanz oder matt satiniert. Schubladen mit Vollauszug mit Push-Pullöffnung. Auf Wunsch auch Schublade mit Hängeregistratur (Für Usa nur "letter size" lieferbar). Auf Anfrage Ausführung ohne Rollen (Gesamthöhe 57,5 cm).

Air Drawer

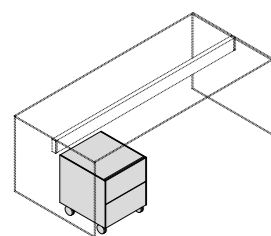

Air Drawer 3

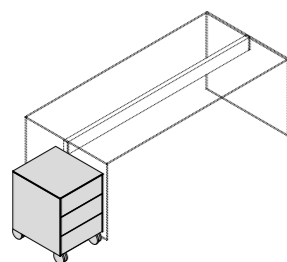

Air Drawer
Air Drawer 3

Cm (L x P x H)

47 x 51 x 56
47 x 51 x 65

Inches (WxDxH)

18¾" x 20¼" x 22¼"
18¾" x 20¼" x 25¾"



Movie Cassettiera

Cassettiera in cristallo trasparente temperato 8mm. Cassetti in legno laccato nero, bianco o grigio umbro a poro chiuso. Serratura solo sul primo cassetto. Parti metalliche in acciaio inox lucido. A richiesta acciaio inox satinato, ottone lucido, satinato o laccato bianco o nero goffrato. Ruote con freno.

Drawer unit in 8mm transparent tempered glass. Black, white or dark grey lacquered closed pore wooden drawers. Lock on the first drawer only. Bright stainless steel metal parts. Satin stainless steel, bright or satin brass or embossed white or black lacquered metal parts, on request. Castors with brake.

Bloc tiroir en verre transparent trempé de 8mm d'épaisseur. Tiroirs en bois laqué noir, blanc ou gris foncé pore fermé. Serrure uniquement sur le premier tiroir. Parties métalliques en acier inox brillant. Sur demande acier inox satiné, laiton brillant, satiné ou laqué blanc ou noir gaufré. Roulettes avec frein.

Rollcontainer: vorgespanntes Glas klar 8mm. 3 Schubladen Holz schwarz, weiss oder dunkelgrau decklackiert. Nur obere Schublade mit Schloss. Metallteile Edelstahl (Inox) poliert. Auf Wunsch Edelstahl (Inox) gebürstet, Messing hochglanz, satiniert oder weiss oder schwarz strukturlackiert. Feststellbare Rollen.

p. 117 Cassettiera in cristallo trasparente e cassetti in legno laccato nero. Parti metalliche in acciaio inox lucido.

Transparent glass drawer unit with black lacquered wooden drawers. Bright stainless steel metal parts.

Bloc tiroir en verre transparent et tiroirs en bois laqué noir. Parties métalliques en acier inox brillant.

Rollcontainer Glas klar und Schubladen Holz Lack schwarz. Metallteile Edelstahl (Inox) poliert.

Cm (L x P x H)
45 x 40 x 67

Inches (W x D x H)
17¾" x 15¾" x 26½"

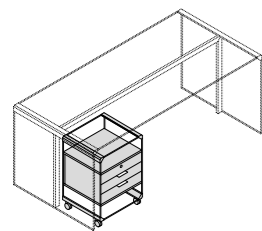

President Cassettiera



Cassettiera in legno rivestito in specchio 6mm o "grigio Italia" 5mm. Montata su ruote. Cassetti in rovere sbiancato, tinto wengé o tinto tabacco. Disponibile anche laccato nero, bianco o grigio umbro a poro chiuso con interni in laminato melaminico di colore grigio. Serratura solo sul primo cassetto. Maniglie in ottone cromato.

Drawer unit in wood with sides covered by 6mm mirror or 5mm smoked "grigio Italia" mirror. On castors. Whitened oak, wengé stained or tobacco stained drawers. Also available with black, white or dark grey closed pore lacquered frontal panels with inside in grey melamine laminated wood. Lock on the first drawer only. Chromed handles.

Bloc tiroir sur roulettes en bois recouvert de miroir de 6mm d'épaisseur ou miroir "grigio Italia" fumé de 5mm d'épaisseur. Tiroirs en chêne blanchi, teinté wengé ou teinté tabac. Disponible aussi laqué noir, blanc ou gris foncé pore fermé avec intérieur en mélaminé de couleur gris. Serrure uniquement sur le premier tiroir. Poignées en laiton chromé.

Rollcontainer aus Holz mit Spiegel 6mm oder Spiegel-Rauchglas "grigio Italia" 5mm umkleidet. Schubladen Holz Eiche gebleicht, Wengé oder Tabakfarbe gebeizt. Lieferbar auch schwarz, weiss oder dunkelgrau decklackiert mit Innenseiten aus grauem Melamin. Obere Schublade mit Schloss. Griffe aus Messingverchromt.

p. 119

Cassettiera in legno rivestito in specchio "grigio Italia". Cassetti in rovere tinto tabacco. Maniglie in ottone cromato.

Drawer unit in wood with sides covered by smoked "grigio Italia" mirror. Tobacco stained oak drawers. Chromed handles.

Bloc tiroir sur roulettes en bois recouvert de miroir "grigio Italia" fumé. Tiroirs en chêne teinté tabac. Poignées en laiton chromé.

Rollcontainer aus Holz mit Spiegel-Rauchglas "grigio Italia" umkleidet. Schubladen Holz Eiche Tabakfarbe gebeizt. Griffe aus Messing verchromt.

Cm (L x P x H)
46 x 46 x 65

Inches (W x D x H)
18¼" x 18¼" x 25¾"

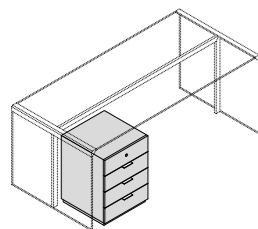

Techna 13

Cassettiera in metallo laccato bianco o nero con frontali rivestiti in cristallo 6mm temperato retroverniciato bianco o nero nella versione brillante o satinata. Montata su ruote. Sistema di chiusura centralizzata e meccanismo antiribaltamento.

Drawer unit in white or black lacquered metal with front panels covered by 6mm white or black painted glass in the bright or satin version. On castors. Centralized locking system and anti-tip mechanism.

Bloc tiroir sur roulettes en métal laqué blanc ou noir. Devant recouvert de verre de 6mm d'épaisseur verni blanc ou noir dans la version brillante ou satiné. Fermeture des tiroirs centralisée et mécanisme de stabilisation.

Rollcontainer aus Metall weiss oder schwarz lackiert mit Schubladenfront Glas 6mm weiss oder schwarz lackiert. Lackierung jeweils hochglanz oder matt satiniert. Zentralverriegelung und Doppelauszugsperrung.

p. 121 Cassettiera montata su ruote in metallo laccato bianco con frontali rivestiti in cristallo retroverniciato bianco satinato.

Drawer unit on castors in white lacquered metal with front panels covered in satin white painted glass.

Bloc tiroir sur roulettes en métal laqué blanc avec devant recouvert de verre verni blanc satiné.

Rollcontainer aus Metall weiss lackiert mit Schubladenfront Glas weiss matt satiniert lackiert.

Cm (L x P x H)
42 x 56 x 54

Inches (W x D x H)
16³/₄" x 22¹/₄" x 21¹/₂"

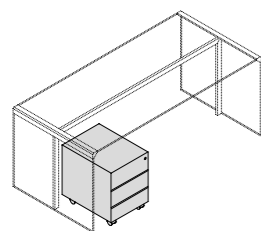

Accessori/ Accessories/ Accessoires / Accessoires

124 Air Pad
124 Cover Cable Plate 1,2
126 Cover Cable Plate 3
126 Glass Pad
126 Mouse Pad
128 Snake
128 Sottomano
128 WGS Glove
130 WGS Screen

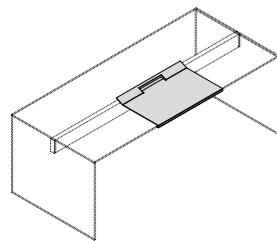
Air Pad

Sottomano in alluminio verniciato bianco o nero effetto gomma.

White or black lacquered aluminium writing pad "rubber finish".

Sous-main en aluminium verni blanc ou noir "finition caoutchouc".

Schreibunterlage aus Aluminium weiss oder schwarz Weichkunststofflackiert.

Cm (L x P x H)
65 x 43 x 2

Inches (W x D x H)
25¾" x 17" x 1"

Cover cable plate 1

Cover cable plate 1 è solo per tavolo Dolm e Akim.

Cover cable plate 1 is only for Dolm and Akim table.

Cover cable plate 1 est seulement pour la table Dolm et Akim.

Cover cable plate 1 ist nur für Tisch Dolm und Akim.

Cm (L x P)
8 x 21

Inches (W x D)
3¼" x 8½"

Cover cable plate 2

Passacavi in alluminio brillante.

Bright aluminium cable management.

Cache fils en aluminium brillant.

Kabeldurchglass aus Aluminium hochglänzend poliert.

p. 125

Passacavi in alluminio brillante.

Bright aluminium cable management.

Cache fils en aluminium brillant.

Kabeldurchglass aus Aluminium hochglänzend poliert.

Cm (L x P)
8 x 21

Inches (W x D)
3¼" x 8½"

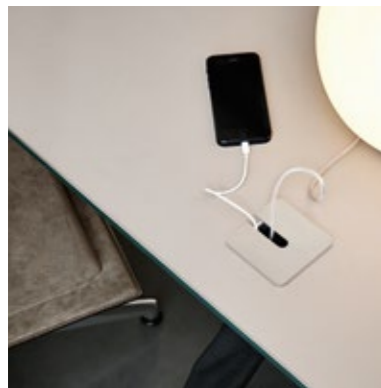

Cover cable plate 3

Passacavi in alluminio brillante. Su richiesta può essere verniciato nella stessa tonalità del cristallo.

Bright aluminium cable management. It can be painted in the same colour of the glass top, on request.

Cache fils en aluminium brillant. Sur demande disponible verni dans les mêmes coloris du plateau en verre.

Kabeldurchlass aus Aluminium hochglänzend poliert. Auf Wunsch in der gleichen Farben der Glasplatte lackiert.

Cm (L x P)

8 x 8

Inches (W x D)

3¼" x 3¼"

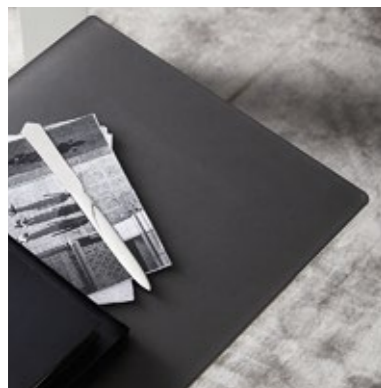
Glass Pad

Sottomano in cristallo temperato retroverniciato satinato nei colori del campionario.

Tempered satin painted glass writing pad as per samples.

Sous-main en verre trempé verni satiné dans les coloris de nos échantillons.

Schreibunterlage aus Glas vorgespannt matt satiniert nach Musterkarte lackiert.

Cm (L x P x H)

70 x 38 x 0,6



Inches (W x D x H)

27¾" x 15" x 1/4"



President Junior

65 x 41 x 0,6



25¾" x 16¾" x 1/4"



President Senior

75 x 43 x 0,6



29¾" x 17" x 1/4"

Mouse Pad

Mouse pad in cristallo retroverniciato satinato nei colori del campionario.

Satin painted glass mouse pad as per samples.

Mouse pad en verre verni satiné dans les coloris de nos échantillons.

Mouse pad aus Glas matt satiniert nach Musterkarte lackiert.

p. 127

Mouse pad in cristallo temperato retroverniciato grigio beige.

Mouse pad in taupe powder tempered painted glass.

Mouse pad en verre trempé verni taupe satiné.

Mouse pad aus Glas vorgespannt Beigegrau matt satiniert.

Cm (L x P)

23 x 23

Inches (W x D)

9¼" x 9¼"



Snake

Portacavi in plastica trasparente. Si applica all'interno del foro oppure sul bordo del piano.

Trasparent plastic cable management. To be fixed to the hole or to the edge of the top.

Porte câbles en plastique transparent. Se positionne à l'intérieur du trou ou au bord du plateau.

Der Kabelkanal aus transparentem Kunststoff wird in der Bohrung oder an der Platte befestigt.

Cm (L x P x H)
ø 6 x 83

Inches (W x D x H)
ø 2½" x 32¾"

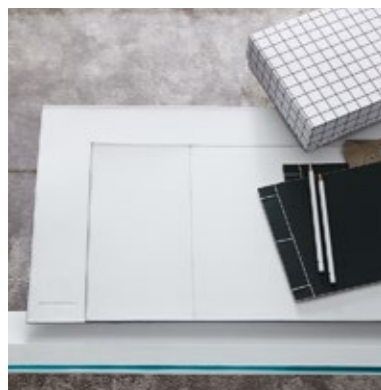
Sottomano

Sottomano in cuoio o pelle scamosciata. Disponibile nei colori del campionario.

Leather or suede writing pad. Available in the finishes as per samples.

Sous-main en cuir ou suédine. Disponible dans les coloris de nos échantillons.

Schreibtischunterlage aus Leder oder Wildleder. Lieferbar in den Farben nach Musterkarte.

	Cm (L x P)		
Elegance	81 x 35	□	
President Junior	65 x 43	□	
President Senior	75 x 45	□	

	Inches (W x D)		
	31¾" x 13¾"	□	
	25¾" x 17"	□	
	29¾" x 17¾"	□	

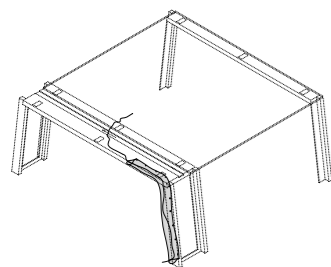
WGS Glove

Passacavi in feltro "natural", per "cavalletto doppio" WGS. Completamente ispezionabile grazie ad un sistema di chiusura a velcro.

Felt cable management in "natural" colour for WGS "double leg". Totally inspectable thanks to a velcro closure system.

Sachet cache-fils en feutre "natural" pour WGS "double chevalet". Complètement accessible par un système de fermeture avec velcro.

Kabelabdeckung aus Filz "natural" für WGS "Doppelreiter". Durch Klettverschluss ganz erreichbar.

Cm (L x P x H)
110 x 8 x 2

Inches (W x D x H)
43½" x 3¼" x 1"

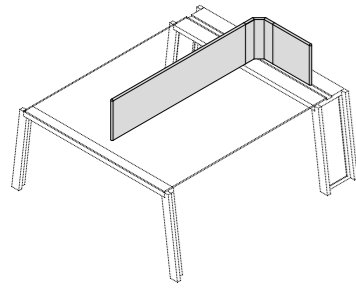

WGS Screen

Divisorio da tavolo in legno rivestito in feltro "natural". Applicabile solo sul sistema modulare WGS a "cavalletto doppio" con prof. 140 cm.

Table divider in wood covered by "natural" felt. It can be placed only on the modular system WGS with "double leg" cm 140 deep.

Séparateur de table en bois recouvert en feutre "natural". Il peut être fixé seulement sur le système modulable WGS avec "double chevalet" prof. cm 140.

Tisch-Trennwand aus Holz mit Filz "natural" bezogen. Ausschliesslich für das Modular WGS-System "Doppelreiter" Tiefe 140 verwendbar.

Cm (L x P x H)	Inches (W x D x H)
100 x 54 x 35	39½" x 21½" x 14"
120 x 54 x 35	47¼" x 21½" x 14"
140 x 54 x 35	55¼" x 21½" x 14"



Contenitori/ Storage Units/ Meubles/ Sideboards

134 Air Unit
142 Air Up
148 Air Shelf
150 Air Wheel
152 Erminia

Air Unit

Sistema modulare di contenitori in legno rivestito in cristallo 6mm retroverniciato nei colori del campionario nella versione brillante o satinata. Disponibile con spalla portante in cristallo extralight temperato 12mm oppure nella versione pensile. Per composizioni a centrostanza è previsto, opzionale, lo schienale in cristallo 6mm retroverniciato. Parti metalliche in alluminio anodizzato brillante. L'interno del mobile Air è in laminato effetto pelle color visone.

Modular system of wooden elements covered by 6mm painted glass as per samples in the bright or satin version. Available as freestanding version with 12mm tempered extralight glass side or suspended version. For compositions as a room divider is available a 6mm painted glass back. Bright anodised aluminium metal parts. The inside of Air Unit is made of leather effect laminated wood in mink colour.

Système modulaire de meubles en bois recouvert de verre verni de 6mm d'épaisseur dans les coloris de nos échantillons dans la version brillante ou satinée. Disponible version sur pieds avec côtés portantes en verre extralight trempé de 12mm d'épaisseur ou version murale. Pour le positionner comme séparateur de pièce est disponible le fond en verre verni de 6mm d'épaisseur. Parties métalliques en aluminium anodisé brillant. La partie intérieure du meuble Air Unit est revêtue en bois laminé effet cuir couleur vison.

Modulsystem aus Holzelementen mit nach Musterkarte lackiertem Glas 6mm umkleidet. Lackierung jeweils hochglanz oder matt satiniert. Lieferbar wie freistehende Komposition mit Seitenwange Glas Extralight vorgespannt 12mm oder wie Hängekomposition. Sodass ein freistehender Einsatz möglich ist, wird mit lackiertem Glasrückwand 6mm geliefert. Metallteile eloxiertes Aluminium hochglänzend poliert. Die Innenwände der Air-Möbel sind aus Holz mit Leder-Effekt in Nerzfarbe umkleidet.

p. 135 **Composizione pensile da 364x51x74h cm rivestita in cristallo retro verniciato oliva satinato. Sedie OFX 09 h85 cm in pelle scamosciata Sand 006.**

Suspended composition 364x51x74h cm covered by satin olive painted glass. Chairs OFX 09 h85 cm in suede Sand 006.

Composition murale de 364x51x74h cm recouverte de verre verni olive satiné. Chaises OFX 09 h85 cm en suédine Sand 006.

Hänge-Komposition 364x51x74h cm mit olivenfarbenen matt satiniertem Glas umkleidet. Stühle OFX 09 h85 cm Wildleder Sand 006.

pp. 136-137 **Composizione da 244x51x91h cm rivestita in cristallo retroverniciato grigio beige brillante.**

Composition 244x51x91h cm covered by bright taupe painted glass.

Composition de 244x51x91h cm recouverte de verre verni taupe brillant.

Komposition 244x51x91h cm mit beige-grau hochglänzendem lackiertem Glas umkleidet.





p. 139 Dettaglio dell'apertura a ribalta del modulo U06R. L'interno del mobile Air Unit è in laminato effetto pelle.

Detail of the flap door of the module U06R. The inside of Air Unit is made of leather effect laminated wood.

Détail de la porte abattante du meuble U06R. La partie intérieure du meuble Air Unit est revêtu en effet cuir.

Detail der Klapptür von U06R. Die Innenwände der Air Unit-Möbel sind aus Holz mit Leder-Effekt umkleidet.

Il sistema Air Unit è disponibile con spalla portante in cristallo trasparente extralight temperato 12 mm oppure nella versione pensile. Per composizioni a centrostanza è previsto lo schienale in cristallo retroverniciato. Parti metalliche in alluminio anodizzato brill.

Air Unit system is available as freestanding version with 12 mm tempered extralight transparent glass side or as suspended version. For compositions as room dividers, is available a painted glass back. Bright anodised aluminium metal parts.

Système Air Unit est disponible dans la version sur pieds par spalles portantes en verre transparent extralight trempé de 12 mms d'épaisseur ou dans la version murale. Pour le positionner comme séparateur de pièce est disponible un fond en verre verni. Parties métalliques en aluminium anodisé brillant.

Air Unit System ist wie freistehende Komposition mit Seitenwange Glas klar Extralight vorgespannt 12 mm oder wie Hängekomposition lieferbar. Sodass ein frestehender Einsatz möglich ist, wird mit lackiertem Glasrückwand geliefert. Metallteile eloxiertes Aluminium hochglänzend poliert.



A

B

C

D

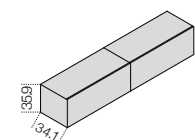

A **Versione pensile U06.** Disponibile solo per i moduli U06, U06R, U06V.

Suspended version U06. Available only for U06, U06R, U06V units.

Version murale U06. Disponible seulement pour les modules U06, U06R, U06V.

Hänge-Komposition U06. Lieferbar nur für die Module U06, U06R, U06V.

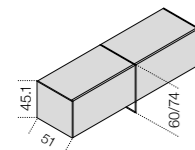

B **Versione pensile + spalla intermedia.** La spalla intermedia 60/74h cm è indispensabile per lo scarico del peso.

Suspended version + middle side. The 60/74h cm middle side is necessary to reduce the weight.

Version murale + côté intermediaire. Le côté intermediaire de 60/74h cm est indispensable pour reduire le poids.

Hänge-Komposition + Zwischenwange. Die Zwischenwange 60/74h cm ist notwendig für Gewichtsverteilung.

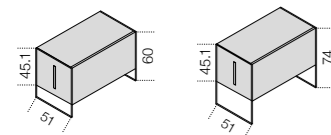

C **Versione a spalla portante 60/74h cm.**

Freestanding version 60/74h cm.

Version sur pieds par spalles portantes 60/74h cm.

Freistehende Komposition 60/74h cm.

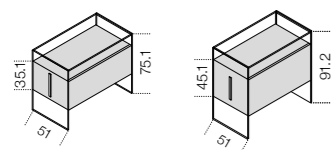

D **Versione a spalla portante 75.1/91.2h cm con vano a giorno.** Dimensione massima della composizione 365 cm.

Freestanding version 75.1/91.2h cm with open unit. Maximum length of the composition 365 cm.

Version sur pieds par spalles portantes 75.1/91.2h cm avec un espace ouvert. Longueur maxime de la composition 365 cm.

Freistehende Komposition 75.1/91.2h cm mit offenem Fach. Max. Länge der Komposition 365 cm.



Storage Units

Versione pensile + spalla intermedia 60/74h cm. Suspended version + mid-side 60/74h cm. Version murale + côté intermédiaire 60/74h cm. Hänge-Komposition + Zwischenwange 60/74h cm.

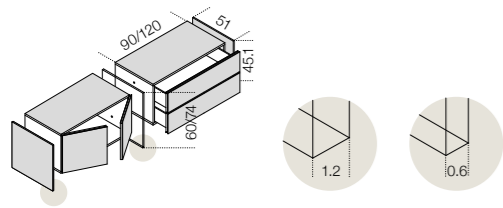

Versione a spalla portante 60/74h cm. Freestanding version 60/74h cm. Version sur pieds par spalles portantes 60/74h cm. Freistehende Komposition 60/74h cm.

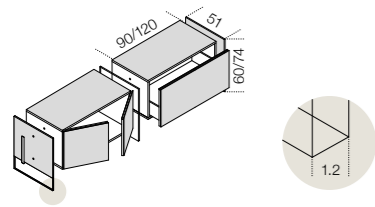

Versione a spalla portante 91.2h cm con vano a giorno. Freestanding version 91.2h cm with open unit. Version sur pieds par spalles portantes 91.2h cm avec un espace ouvert. Freistehende Komposition 91.2h cm mit offenem Fach.

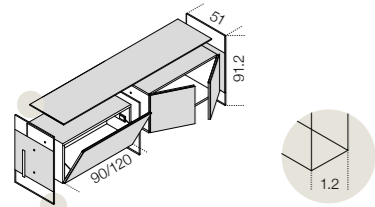

Moduli Air Unit h 45.1 cm. Air Unit modules h 45.1 cm. Meubles Air Unit h 45.1 cm. Air Unit-Möbel h 45.1 cm.

Cm (L x P x H) 90 x 51 x 45.1
Inches (W x D x H) 35½" x 20¼" x 18"
120 x 51 x 45.1 47¼" x 20¼" x 18"

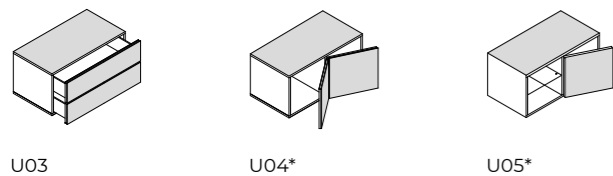
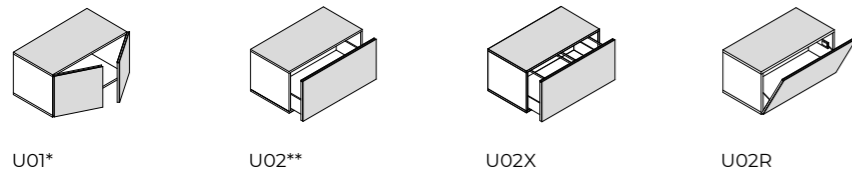

Storage Units

Versione pensile U06. Suspended version U06. Version murale U06. Hänge-Ausführung U06.

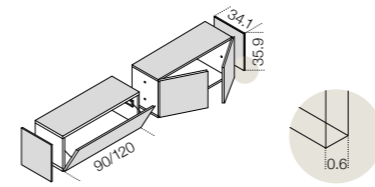

Moduli Air Unit h 35.9 cm. Air Unit modules h 35.9 cm. Meubles Air Unit h 35.9 cm. Air Unit-Möbel h 35.9 cm.

Cm (L x P x H) 90 x 34.1 x 35.9
Inches (W x D x H) 35½" x 20¼" x 14"
120 x 34.1 x 35.9 47¼" x 20¼" x 14"
35.9 x 34.1 x 91.4 U06V 14¼" x 13½" x 36"
35.9 x 34.1 x 121.4 U06V 14¼" x 13½" x 48"

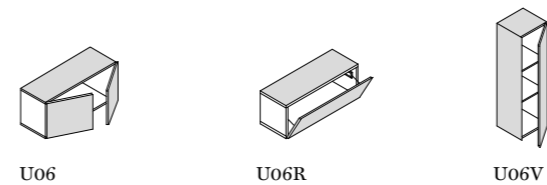

Versione a spalla portante 75.1h cm con vano a giorno. Freestanding version 75.1h cm with open unit. Version sur pieds par spalles portantes 75.1h cm avec un espace ouvert. Freistehende Komposition 75.1h cm mit offenem Fach.

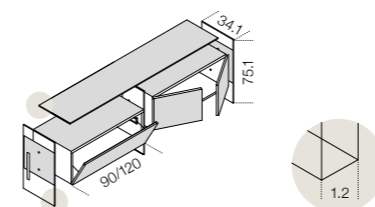

Moduli Air Unit h 35.1 cm. Air Unit modules h 35.1 cm. Meubles Air Unit h 35.1 cm. Air Unit-Möbel h 35.1 cm.

Cm (L x P x H) 90 x 51 x 35.1
Inches (W x D x H) 35½" x 20¼" x 14"
120 x 51 x 35.1 47¼" x 20¼" x 14"

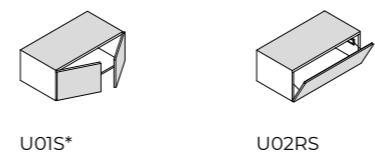

***Può essere dotato di ripiano interno in cristallo trasparente extralight.** *It can be supplied with one inside extralight transparent glass shelf. *Il peut être livré avec une tablette intérieure en verre transparent extralight. *Es wird auf Wunsch mit einem Innenboden aus Extralight Glas geliefert.

****Può essere dotato di un cassetto interno.** **It can be supplied with one inside drawer. **Il peut être livré avec un tiroir intérieur. **Es wird auf Wunsch mit einer Innenschublade geliefert.

Air Up

Sistema di mobili contenitori sovrapposti in legno rivestito in cristallo 6mm retroverniciato nei colori del campionario, nella versione brillante o satinata. Base e distanziatori in legno laminato effetto pelle. Parti metalliche in alluminio anodizzato brill. Per composizioni a centrostanza è previsto lo schienale in cristallo retroverniciato. L'interno del mobile Air Up è in laminato effetto pelle color visone. È consigliabile una sovrapposizione di massimo 3 moduli.

Modular system of superimposed wooden elements covered by 6mm painted glass as per samples, in the bright or satin version. Base and spacers in leather effect laminated wood. Bright anodised aluminium metal parts. For compositions as room divider, is available a painted glass back. The inside of Air Up is made of leather effect laminated wood in mink colour. Stacking up to 3 modules is recommended.

Système modulaire de meubles superposés en bois recouvert de verre verni de 6mm d'épaisseur dans les couleurs de nos échantillons dans la version brillante ou satinée. Socle et pièces entretoisées en bois revêtu en effet cuir. Parties métalliques en aluminium anodisé brillant. Pour le positionner comme séparateur de pièce est disponible le fond en verre verni. La partie intérieure du meuble Air Up est revêtue en bois laminé effet cuir couleur vison. On recommande un empilement de 3 modules maximum.

Modulsystem aus Aneinandergesetzten Holzelementen mit nach Musterkarte lackiertem Glas 6mm umkleidet. Lackierung jeweils hochglanz oder matt satiniert. Holzsockel und Abstandteile mit Leder-Effekt umkleidet. Metallteile eloxiertes Aluminium hochglänzend poliert. Sodass ein freistehender Einsatz möglich ist, wird mit lackiertem Glasrückwand geliefert. Die Innenwände der Air Up-Möbel sind aus Holz mit Leder-Effekt in Nerzfarbe umkleidet. Eine Aufbauhöhe bis maximal drei Module wird empfohlen.

p. 143	Composizione da 121,5x51 x143h cm rivestita in cristallo retroverniciato grigio beige brillante. Tavolino Raj 2.	Composition 121,5x51 x143h cm covered by bright taupe painted glass. Raj 2.	Composition de 121,5x51 x143h cm recouverte de verre verni taupe brillant. Raj 2 table basse.	Komposition 121,5x51 x143h cm mit beige-grau hochglänzendem lackiertem Glas umkleidet. Raj 2 Couchtisch.
pp. 144-145	Vassoio portacancellaria in alluminio applicabile al cassetto del mobile U02/U03.	Aluminium stationery tray available for the drawer of the unit U02/U03.	Plateau porte-plumes en aluminium disponible pour le tiroir du meuble U02/U03.	Utensilientablett aus Aluminium kann auf der Schublade von dem Modul U02/U03 angebracht werden.
pp. 144-145	Cassetto ad estrazione totale con fondo in cristallo trasparente.	Total pull-out drawer with transparent glass bottom.	Tiroir complètement extractible et fond en verre transparent.	Schublade mit Vollauszug und Boden aus Klarglas.





Storage Units

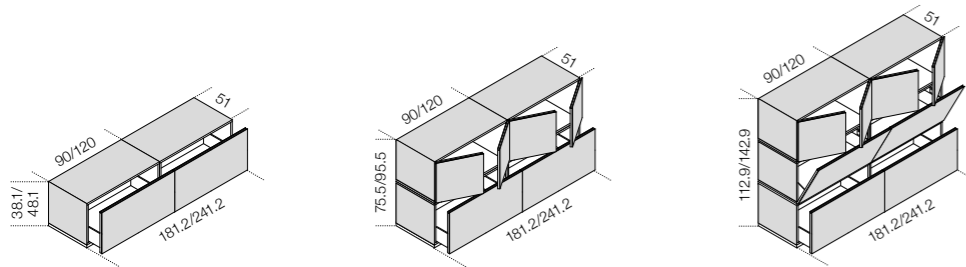

Moduli Air Up h 48.1 cm. Air Up modules h 48.1 cm. Meubles Air Up h 48.1 cm. Air Up-Möbel h 48.1 cm.

Cm (L x P x H)

Inches (W x D x H)

90 x 51 x 48.1
120 x 51 x 48.1

35½" x 20¾" x 19"
47¼" x 20¾" x 19"

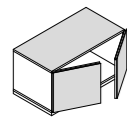

U01 UP*

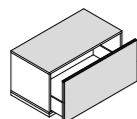

U02 UP**

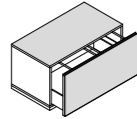

U02X UP

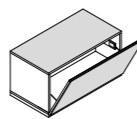

U02R UP

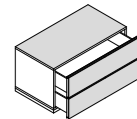

U03 UP

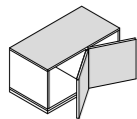

U04 UP*

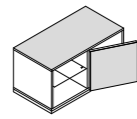

U05 UP*

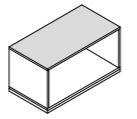

U07 UP*

Moduli Air Up S h 38.1 cm.

Air Up S modules h 38.1 cm.

Meubles Air Up S h 38.1 cm.

Air Up S-Möbel h 38.1 cm.

Cm (L x P x H)

Inches (W x D x H)

90 x 51 x 38.1
120 x 51 x 38.1

35½" x 20¾" x 15¼"
47¼" x 20¾" x 15¼"

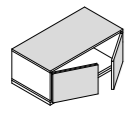

U01S UP*

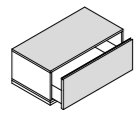

U02S UP

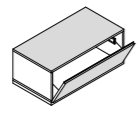

U02RS UP

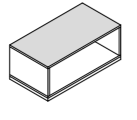

U07S UP*

*Può essere dotato di ripiano interno in cristallo trasparente extralight.

*It can be supplied with one inside extralight transparent glassshelf.

*Il peut être livré avec une tablette intérieure en verre transparent extralight.

*Es wird auf Wunsch mit einem Innenboden aus Extralight Glas geliefert.

**Può essere dotato di un cassettino interno.

**It can be supplied with one inside drawer.

**Il peut être livré avec un tiroir intérieur.

**Es wird auf Wunsch mit einer Innenschublade geliefert.



Air Up Shelf

Sistema di mobili contenitori sovrapposti in legno rivestito in cristallo retroverniciato nei colori del campionario, nella versione brillante o satinata. Base e distanziatori in legno laminato effetto pelle. Parti metalliche in alluminio anodizzato brill. Per composizioni a centrostanza è previsto lo schienale in cristallo retroverniciato. L'interno del mobile Air Up Shelf è in laminato effetto pelle. Spalla in cristallo extralight temperato 12mm retroverniciata in corrispondenza del fianco del mobile. Top in cristallo extralight temperato 12mm.

Modular system of superimposed wooden elements covered by painted glass as per samples, in the bright or satin version. Base and spacers in leather effect laminated wood. Bright anodised aluminium metal parts. For room dividers, a painted glass back is available. The inside of Air Up Shelf is made of leather effect laminated wood. 12mm extralight glass side, painted in the part corresponding to the unit's side. 12mm extralight tempered glass top.

Système modulaire de meubles superposés en bois recouvert de verre verni dans les coloris de nos échantillons dans la version brillante ou satinée. Socle et pièces entretoisées en bois revêtu en effet cuir. Parties métalliques en aluminium anodisé brillant. Pour le positionner comme séparateur de pièce est disponible le fond en verre verni. La partie intérieure du meuble Air Up Shelf est revêtu en effet cuir. Côté en verre extralight trempé de 12mm d'épaisseur, vernie dans la partie correspondante au côté du meuble. Top en verre extralight trempé de 12mm d'épaisseur.

Modulsystem aus aneinandergesetzten Holzelementen mit nach Musterkarte lackiertem Glas. Lackierung jeweils hochglanz oder matt satiniert. Holzsockel und Abstandteile mit Leder-Effekt umkleidet. Metallteile eloxiertes Aluminium hochglänzend poliert. Sodass ein freistehender Einsatz möglich ist, wird mit lackiertem Glasrückwand geliefert. Die Innenwände der Air Up Shelf-Möbel sind aus Holz mit Leder-Effekt umkleidet. Seitenwange aus vorgespanntem Glas Extralight 12 mm lackiert entsprechend der Möbelseite. Abdeckboden aus vorgespanntem Glas Extralight 12 mm.

p. 149 **Composizione da 365x51 x133,4h cm rivestita in cristallo retroverniciato cemento brillante.**

Composition 365x51 x133,4h cm covered by bright cement painted glass.

Composition de 365x51 x133,4h cm recouverte de verre verni ciment brillant.

Komposition 365x51 x133,4h cm mit zement hochglänzendem lackiertem Glas umkleidet.

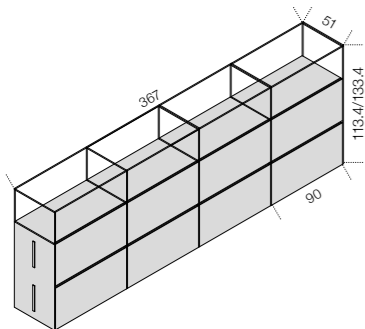
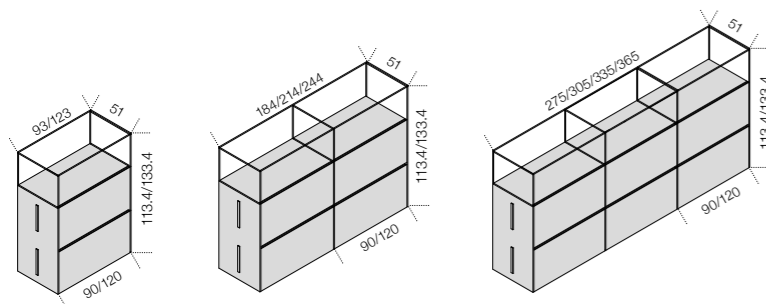

Cm (L x P x H)

93 x 51 x 113.4
123 x 51 x 113.4
184 x 51 x 113.4
214 x 51 x 113.4
244 x 51 x 113.4
275 x 51 x 113.4
305 x 51 x 113.4
335 x 51 x 113.4
365 x 51 x 113.4
367 x 51 x 113.4
93 x 51 x 133.4
123 x 51 x 133.4
184 x 51 x 133.4
214 x 51 x 133.4
244 x 51 x 133.4
275 x 51 x 133.4
305 x 51 x 133.4
335 x 51 x 133.4
365 x 51 x 133.4
367 x 51 x 133.4

Inches (W x D x H)

36³/₄" x 20³/₄" x 44³/₄"
48¹/₂" x 20³/₄" x 44³/₄"
72¹/₂" x 20³/₄" x 44³/₄"
84¹/₂" x 20³/₄" x 44³/₄"
96¹/₄" x 20³/₄" x 44³/₄"
108¹/₂" x 20³/₄" x 44³/₄"
120¹/₄" x 20³/₄" x 44³/₄"
132" x 20³/₄" x 44³/₄"
143³/₄" x 20³/₄" x 44³/₄"
144¹/₂" x 20³/₄" x 44³/₄"
36³/₄" x 52¹/₂" x 44³/₄"
48¹/₂" x 52¹/₂" x 44³/₄"
72¹/₂" x 52¹/₂" x 44³/₄"
84¹/₂" x 52¹/₂" x 44³/₄"
96¹/₄" x 52¹/₂" x 44³/₄"
108¹/₂" x 52¹/₂" x 44³/₄"
120¹/₄" x 52¹/₂" x 44³/₄"
132" x 52¹/₂" x 44³/₄"
143³/₄" x 52¹/₂" x 44³/₄"
144¹/₂" x 52¹/₂" x 44³/₄"



Air Wheel

Mobile contenitore montato su ruote ed interamente rivestito in cristallo 6mm retroverniciato nei colori del campionario, nella versione brillante o satinata. Cassetti ad estrazione totale con fondo in cristallo trasparente temperato 4mm. Fondo in laminato effetto pelle e ruota supplementare solo per le versioni AWU02X e AW02X. L'interno del mobile Air è in laminato effetto pelle. Su richiesta versione senza ruote, con zoccolo laminato effetto pelle (altezza totale 38 o 48cm).

Wooden unit on castors with all sides covered by 6mm painted glass as per samples, in the bright or satin version. Total pull-out drawers with 4mm tempered transparent bottom glass. Leather effect laminated wooden bottom and additional castor for AWU02X e AW02X. The inside of Air Wheel is made of leather effect laminated wood. On request, version without castors, with leather effect laminated wooden plinth (total height 38 or 48 cm).

Meuble sur roulettes avec tous les côtés recouverts de verre de 6mm d'épaisseur verni dans les coloris de nos échantillons dans la version brillante ou satinée. Tiroirs complètement extractibles et fond en verre transparent trempé de 4mm d'épaisseur. Fond revêtu en effet cuir et roulette supplémentaire seule pour les versions AWU02X e AW02X. La partie intérieure du meuble Air Wheel est revêtu en effet cuir. Disponible sans roulettes avec socle en bois revêtu en effet cuir (hauteur totale 38 ou 48 cm).

Holzelement auf Rollen mit allen Seiten nach Musterkarte lackiertem Glas 6mm umkleidet. Lackierung jeweils hochglanz oder matt satiniert. Schubladen mit Vollauszug und Boden aus vorgespannt Klarglas 4mm. Boden mit Leder-Effekt umkleidet und zusätzliche Rollen nur für die Ausführung AWU02X und AW02X. Die Innenwände der Air Wheel sind aus Holz mit Leder-Effekt umkleidet. Auf Wunsch ohne Rollen mit Sockel aus Holz mit Leder-Effekt umkleidet (Gesamthöhe 38 oder 48 cm).

p.151 Contenitore rivestito in cristallo retroverniciato oliva satinato da 137x51 x56h cm. Scrivania Air Desk in cristallo trasparente extralight da 180x90x74h cm e parti metalliche in acciaio inox lucido. Sedia OFX 09 h115 cm in pelle scamosciata Sand 012.

Unit on castors 137x51 x56h cm in satin olive painted glass. Extralight transparent glass desk 180x90x74h cm and bright stainless steel metal parts. Chair OFX 09 h115 cm in suede Sand 012.

Meuble sur roulettes 137 x51x56h cm recouvert de verre verni olive satiné. Bureau Air Desk en verre transparent extralight de 180x90x74h cm et parties métalliques en acier inox brillant. Chaise OFX 09 h115 cm en suédine Sand 012.

Rollcontainer 137x51 x56h cm mit olivenfarben matt satiniertem Glas umkleidet. Schreibtisch Air Desk aus Glas klar Extralight von 180x90 x74h cm und Metallteile Edelstahl (Inox) poliert. Stuhl OFX 09 h115 cm Wildleder Sand 012.

AWU01/U01S

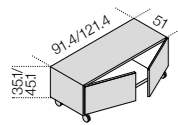

AWU02/U02S

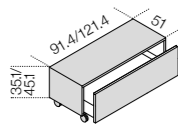

AWU02R/U02RS

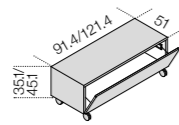

AW01

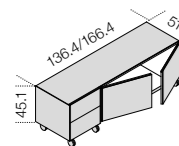

AW02/02X

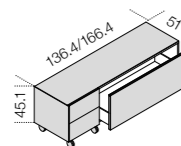

AW02R

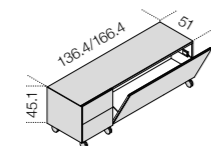

Cm (L x P x H)

91,4 x 51 x 46
121,4 x 51 x 46
91,4 x 51 x 56
121,4 x 51 x 56
136,4 x 51 x 56
166,4 x 51 x 56

Inches (W x D x H)

36" x 20¼" x 18¼"
48" x 20¼" x 18¼"
36" x 20¼" x 22¼"
48" x 20¼" x 22¼"
53¾" x 20¼" x 22¼"
65¾" x 20¼" x 22¼"



Erminia

Madia in legno rivestito in cristallo 6mm temperato retroverniciato nei colori del campionario nella versione brillante o satinata. Struttura in acciaio inox lucido o satinato. A richiesta metallo brunito. Disponibile ripiano interno in cristallo 10mm extralight.

Wooden sideboard covered by 6mm tempered painted glass as per samples in the bright or satin version. Bright or satin stainless steel structure. Burnished metal structure, on request. 10mm extralight inside glass shelf available on request.

Meuble en bois recouvert de verre trempé verni de 6mm d'épaisseur dans les coloris de nos échantillons dans la version brillante ou satinée. Structure en acier inox brillant ou satiné. Sur demande, disponible structure en métal bruni. Disponible sur demande étagère interne en verre extralight de 10mm d'épaisseur.

Holzmöbel mit vorgespannt Glas 6mm nach Musterkarte lackiert umkleidet. Lackierung jeweils hochglanz oder matt satiniert. Träger Edelstahl (Inox) poliert oder gebürstet. Auf Wunsch Träger Metall brunit. Lieferbar auch Innenglasboden Extralight vorgespannt 10mm.

p.153 Madia da 246x51x74h cm, rivestita in cristallo retroverniciato grigio umbro satinato. Struttura in acciaio inox lucido.

Sideboard 246x51x74h cm, covered with satin dark grey painted glass. Bright stainless steel structure.

Dressoir de 246x51x74h cm, recouvert de verre verni gris forcé satiné. Structure en acier inox brillant.

Holzanzicht 246x51x74h cm, mit dunkel grau matt satiniertem Glas umkleidet. Träger Edelstahl (Inox) poliert.



Cm (L x P x H)

94 x 51 x 60
124 x 51 x 60
186 x 51 x 60
246 x 51 x 60
278 x 51 x 60
368 x 51 x 60
94 x 51 x 74
124 x 51 x 74
186 x 51 x 74
246 x 51 x 74
278 x 51 x 74
368 x 51 x 74

Inches (W x D x H)

37 1/4" x 20 1/4" x 23 3/4"
49" x 20 1/4" x 23 3/4"
73 1/4" x 20 1/4" x 23 3/4"
97" x 20 1/4" x 23 3/4"
109 1/2" x 20 1/4" x 23 3/4"
145" x 20 1/4" x 23 3/4"
37 1/4" x 20 1/4" x 29 1/4"
49" x 20 1/4" x 29 1/4"
73 1/4" x 20 1/4" x 29 1/4"
97" x 20 1/4" x 29 1/4"
109 1/2" x 20 1/4" x 29 1/4"
145" x 20 1/4" x 29 1/4"



Finiture/ Finishes/ Finitions/ Ausführungen

156 Glass
157 Metal
158 Wood
159 Suede
159 Eco leather
159 Leather (writing pad)
159 Felt WCS
159 Velvet

Finishes

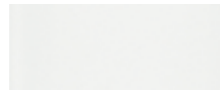
**Cristalli
Glass
Verre
Glas**Trasparente
Transparent
Transparent
Klar

Extralight

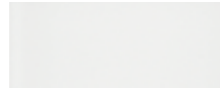
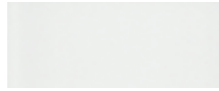
"Grigio Italia"
Smoked "grigio Italia"
"Grigio Italia" fumé
Rauchglas "grigio Italia"Specchio
Mirror
Miroir
SpiegelSpecchio "grigio Italia"
"Grigio Italia" smoked mirror
Miroir "grigio Italia" fumé
Spiegel-Rauchglas "grigio Italia"Stopsol bronzo
Bronze stopsol
Stopsol bronze
Stopsol bronzefarbenBianco brillante
Bright white
Blanc brillant
Weiss hochglänzendBianco satinato
Satin white
Blanc satiné
Weiss matt satiniertNero brillante
Bright black
Noir brillant
Schwarz hochglänzendNero satinato
Satin black
Noir satiné
Schwarz matt satiniertCemento brillante
Bright cement
Ciment brillant
Zement hochglänzendCemento satinato
Satin cement
Ciment satiné
Zement matt satiniertChampagne brillante
Bright champagne
Champagne brillant
Champagne hochglänzendChampagne satinato
Satin champagne
Champagne satiné
Champagne matt satiniertVisone brillante
Bright mink
Vison brillant
Nerzfarbe hochglänzendVisone satinato
Satin mink
Vison satiné
Nerzfarbe matt satiniertCipria brillante
Bright rose powder
Poudre brillant
Puderfarben hochglänzendCipria satinato
Satin rose powder
Poudre satiné
Puderfarben matt satiniertCadet blue brillante
Bright cadet blue
Cadet bleu brillant
Kadettenblau hochglänzendCadet blue satinato
Satin cadet blue
Cadet bleu satiné
Kadettenblau matt satiniertOliva brillante
Bright olive
Vert olive brillant
Olivenfarben hochglänzendOliva satinato
Satin olive
Vert olive satiné
Olivenfarben matt satiniertGrigio beige brillante
Bright taupe
Taupe brillant
Beigegrau hochglänzendGrigio beige satinato
Satin taupe
Taupe satiné
Beigegrau matt satiniertGrigio umbro brillante
Bright dark grey
Gris foncé brillant
Dunkelgrau hochglänzendGrigio umbro satinato
Satin dark grey
Gris foncé satiné
Dunkelgrau matt satiniertBlu grigio brillante
Bright blue-grey
Blue gris brillant
Blau grau hochglänzendBlu grigio satinato
Satin blue-grey
Blue gris satiné
Blau grau matt satiniertLiquirizia brillante
Bright liquorice black
Réglisse brillant
Schwarzbraun hochglänzendLiquirizia satinato
Satin liquorice black
Réglisse satiné
Schwarzbraun matt satiniert

Finishes

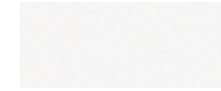
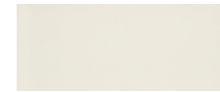
**Metalli
Metal
Métal
Metallteile**Acciaio inox lucido
Bright stainless steel
Acier inox brillant
Edelstahl (Inox) poliertAcciaio inox satinato
Satin stainless steel
Acier inox satiné
Edelstahl (Inox) gebürstetAlluminio anodizzato
Anodised aluminium
Aluminium anodisé
Aluminium eloxiertCromo
Chrome
Chrome
ChromBrunito
Burnished
Bruni
BruniertOttone satinato
Satin brass
Laiton satiné
Messing satiniertOttone
Brass
Laiton
MessingBianco gofrato
Embossed white
Blanc gaufré
Weiss strukturlackiertNero gofrato
Embossed black
Noir gaufré
Schwarz strukturlackiertAlluminio spazzolato nero
Black brushed aluminium
Aluminium brossé noir
Aluminium schwarz gebürstetAlluminio spazzolato titanio
Titanium grey brushed
aluminium
Aluminium brossé gris titane
Aluminium titangrau gebürstetCanapa effetto tessuto
Canapa fabric touch effect
Chanvre effet tissu
Hanffarben Stoff-EffektSabbia effetto tessuto
Sand fabric touch effect
Sablé effet tissu
Sandfarben Stoff-EffektCastagna effetto tessuto
Chestnut fabric touch effect
Châtaigne effet tissu
Kastanienbraun Stoff-Effekt

Finishes

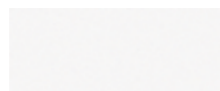
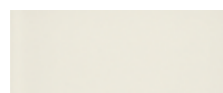
**Legni
Wood
Bois
Holz**Frassino naturale
Natural ash
Frêne naturel
Eschenholz natureRovere spazzolato naturale
Brushed natural oak
Chêne naturel brossé
Eiche natur gebürstetRovere sbiancato
Whitened oak
Chêne blanchi
Eiche gebleichtRovere tinto wengé
Wengé stained oak
Chêne teinté wengé
Eiche wengé gebeiztTinto tabacco
Tobacco stained
Teinté tabac
Tabakfarbe gebezeitBianco poro aperto
White open pore
Blanc pores ouverts
Weiss offenporigBianco poro chiuso
White closed pore
Blanc pores clos
Weiss decklackiertNero poro aperto
Black open pore
Noir pores ouverts
Schwarz offenporigNero poro chiuso
Black closed pore
Noir pores clos
Schwarz decklackiertGrigio umbro poro chiuso
Dark grey closed pore
Gris foncé pores clos
Dunkel grau decklackiertCanapa effetto tessuto
Canapa fabric touch effect
Chanvre effet tissu
Hanffarben Stoff-EffektSabbia effetto tessuto
Sand fabric touch effect
Sablé effet tissu
Sandfarben Stoff-EffektCastagna effetto tessuto
Chestnut fabric touch effect
Châtaigne effet tissu
Kastanienbraun Stoff-Effekt

Finishes

**Pelle scamosciata
Suede
Suédine
Wildleder**

Sand 006



Sand 012



Grey 020



Grey 058

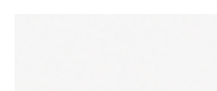
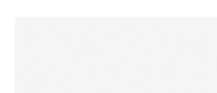

Grey 074

**Ecopelle
Eco leather
Simili cuir
Spaltleder**Bianco
White
Blanc
WeissNero
Black
Noir
Schwarz**Cuoio (Sottomano)
Leather (Writing pad)
Cuir (Sousmain)
Leder (Schreibunterlage)**Bianco
White
Blanc
WeissTortora
Taupe
Taupe
BeigegrauMarrone
Brown
Marron
BraunGrigio
Grey
Gris
GrauNero
Black
Noir
Schwarz**Feltro WGS
Felt WGS
Feutre WGS
Filz WGS**

Natural

**Velluto
Velvet
Velours
Samt**

Ash pink 2703

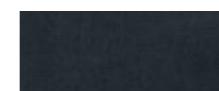

Blue 408



Brick 3701



Mink 519



Moss 7307



Ochre 1688

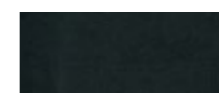

Peacock 705

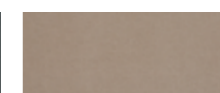

Pearl 206

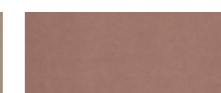

Rose powder 4512



Royal 5438



Sage green 6381



Taupe 537

Credits

Fotolito/Photoengraving
Monogramma

© Gallotti&Radice, 2021

Fotografie/Photos
Federico Cedrone
Sergio Chimenti
Matteo Imbriani

Si ringraziano/Thanks to
Artemide
Giacomelli Giardini
Kasthall
Kristiina Lassus
Living Divani
Oluce
Penta
Pineider

Gallotti&Radice srl
Via Matteotti, 17
22072 Cermenate
(Como) Italy
T +39 031 777111
F +39 031 777188
info@gallottiradice.it
www.gallottiradice.it

